

Cerberus™ PRO

## Fire terminal

FT724



**Compact, pre-assembled fire terminal with integrated, user-friendly operating unit for system operation and display.**

- System operation and display functions
- Ergonomically arranged operating and indication elements grouped according to function
- Large backlit display: 8 lines of 40 characters each
- Convenient context- and state-based operation via soft keys
- One text display with two lines of information for each alarm event
- Ability to store location-specific action texts
- Simultaneous display of multiple events
- Different levels of operation according to access level
- Operating access via a password or optional key switch
- Possible to have several fire terminals per fire detection system
- Extensions: Event printer, power supply, serial interfaces

# Features and Functions

## System



The diagrams have been simplified and do not include additional network hardware or security components. Permissible applications are described in the A6V101039439 Network Security Guidelines document. Contact your Siemens IT security expert for more information.

### System overview

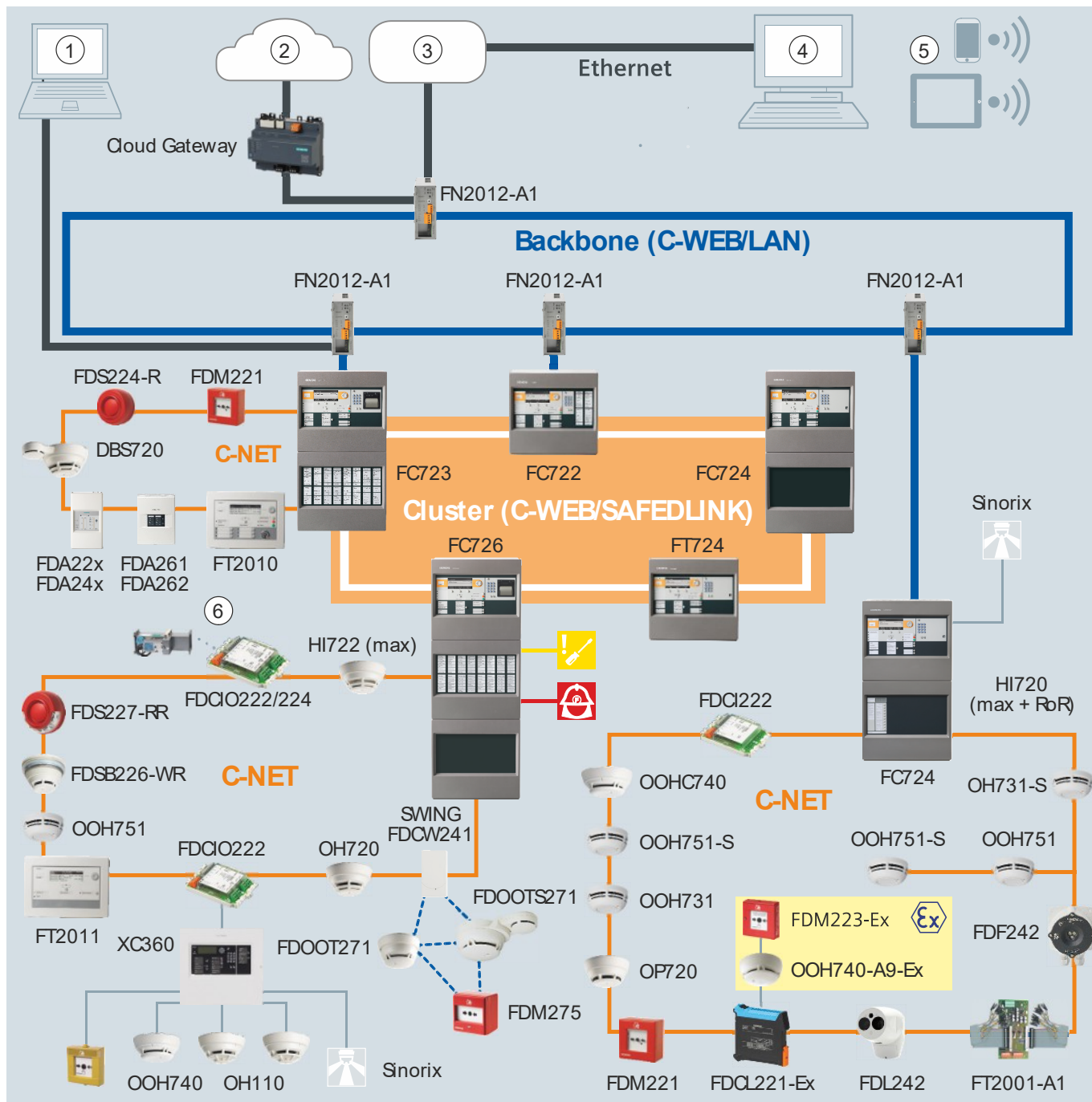



Fig. 1: System overview

1	Remote access with Cerberus-Remote
2	'Cloud for Buildings'
3	Customer network
4	Management platform
5	Remote access to management platform
6	Fire damper with actuator
	Transmission of a fault signal
	Transmission of an alarm signal

You will find a detailed labeled version of the diagram above along with further information in the A6V10332842 planning guide, see chapter 'Product documentation'.

### Networking of fire control panels



The diagrams have been simplified and do not include additional network hardware or security components. Permissible applications are described in the A6V101039439 Network Security Guidelines document. Contact your Siemens IT security expert for more information.

Up to 32 control panels and terminals can be linked to form one C-WEB network. If the C-WEB network is connected to a danger management system via BACnet, up to 16 control panels and terminals can be networked.

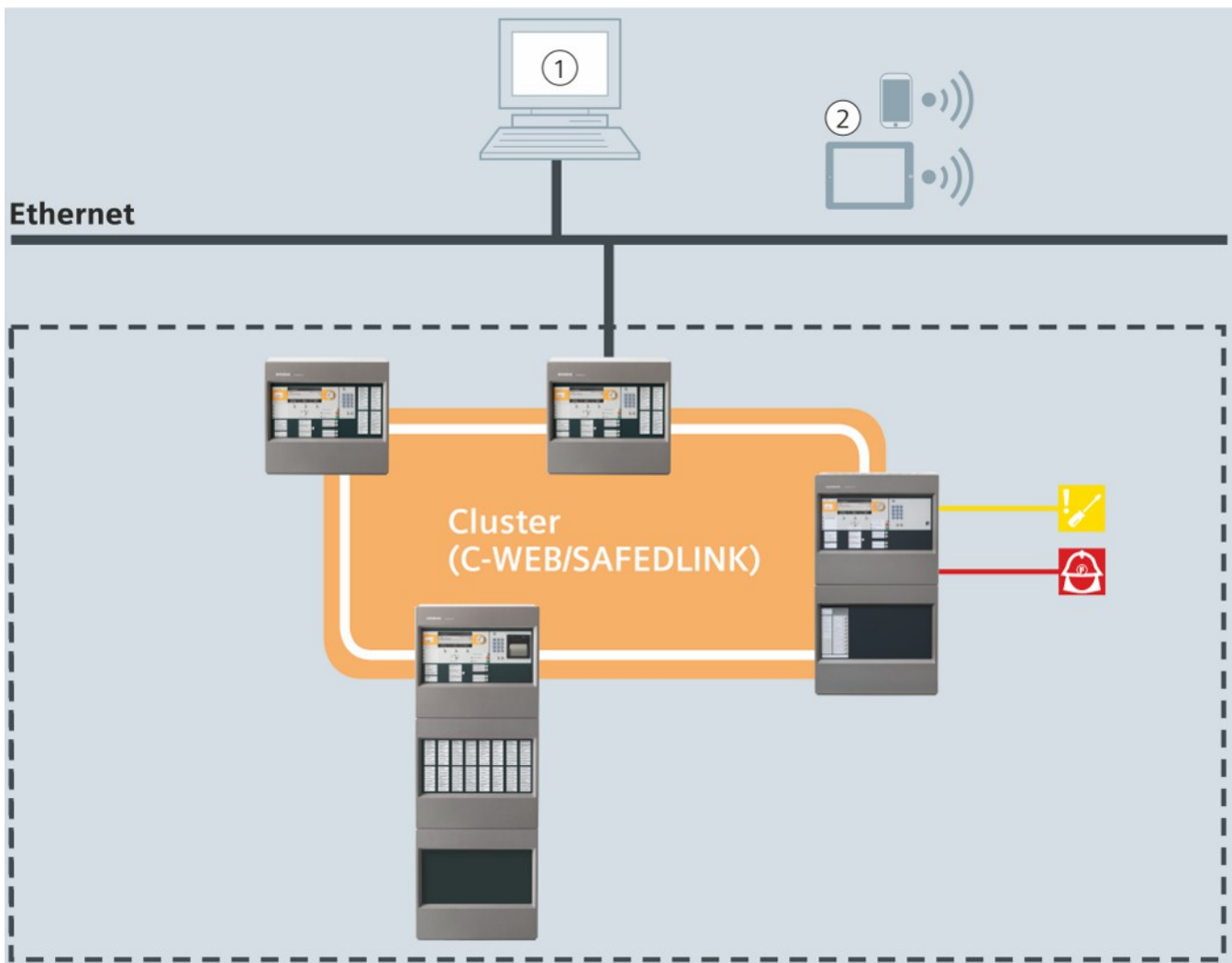

Fig. 2: Sub-net

1	Management platform
2	Remote access to management platform
	Transmission of a fault signal
	Transmission of an alarm signal

An optical C-WEB/LAN network (without sub-networks) allows operation of a maximum of 64 stations in a single network.

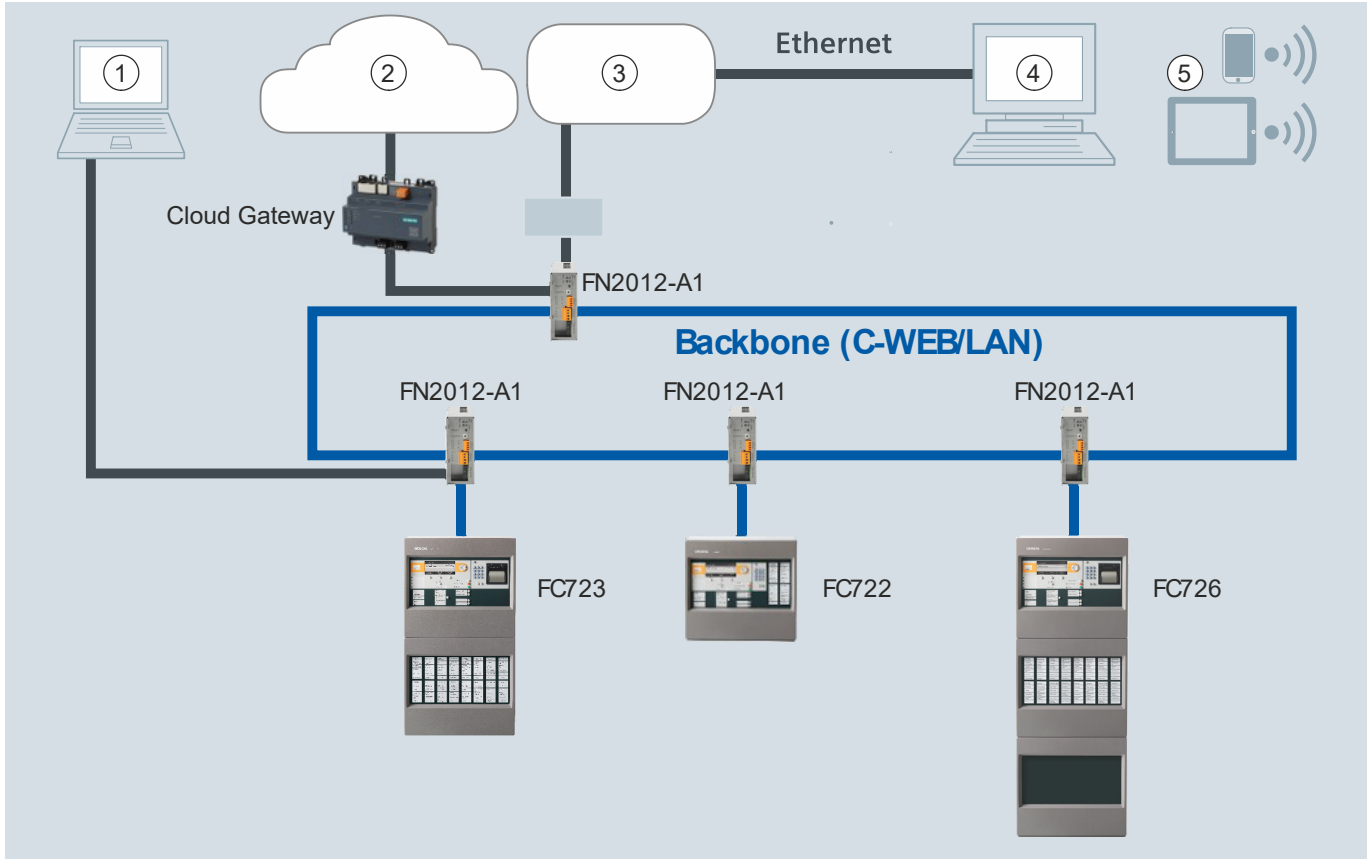

Fig. 3: Networking via 'C-WEB/LAN' without a 'subnet'

1	Remote access with Cerberus-Remote
2	'Cloud for Buildings'
3	Customer network
4	Management platform
5	Remote access to management platform

You will find a detailed labeled version of the diagram above along with further information in the A6V10332842 planning guide, see chapter 'Product documentation'.

An extended redundant network via 'C-WEB/LAN' without a sub-net is a glass fiber Ethernet network without 'SAFEDLINK sub-net'. This type of networking meets the requirements for communication in 'Degraded mode' and is EN-54-compliant.

The following preconditions/restrictions are applicable:

- To ensure EN-54 conformity, the following setting must be activated in the 'Cerberus-Engineering-Tool': 'Degraded signal forwarding enabled'.
- The network must be implemented via one connection module (MoNet) FCA2031-A1 and one Ethernet switch (modular) FN2012 per 'Station' in each case.
- A maximum of 64 'Stations' can be networked via the 'C-WEB/LAN' without a sub-net.

An optical C-WEB/LAN network allows up to 14 sub-nets with up to 16 stations to be operated in one network. A maximum of 64 stations is supported in total.

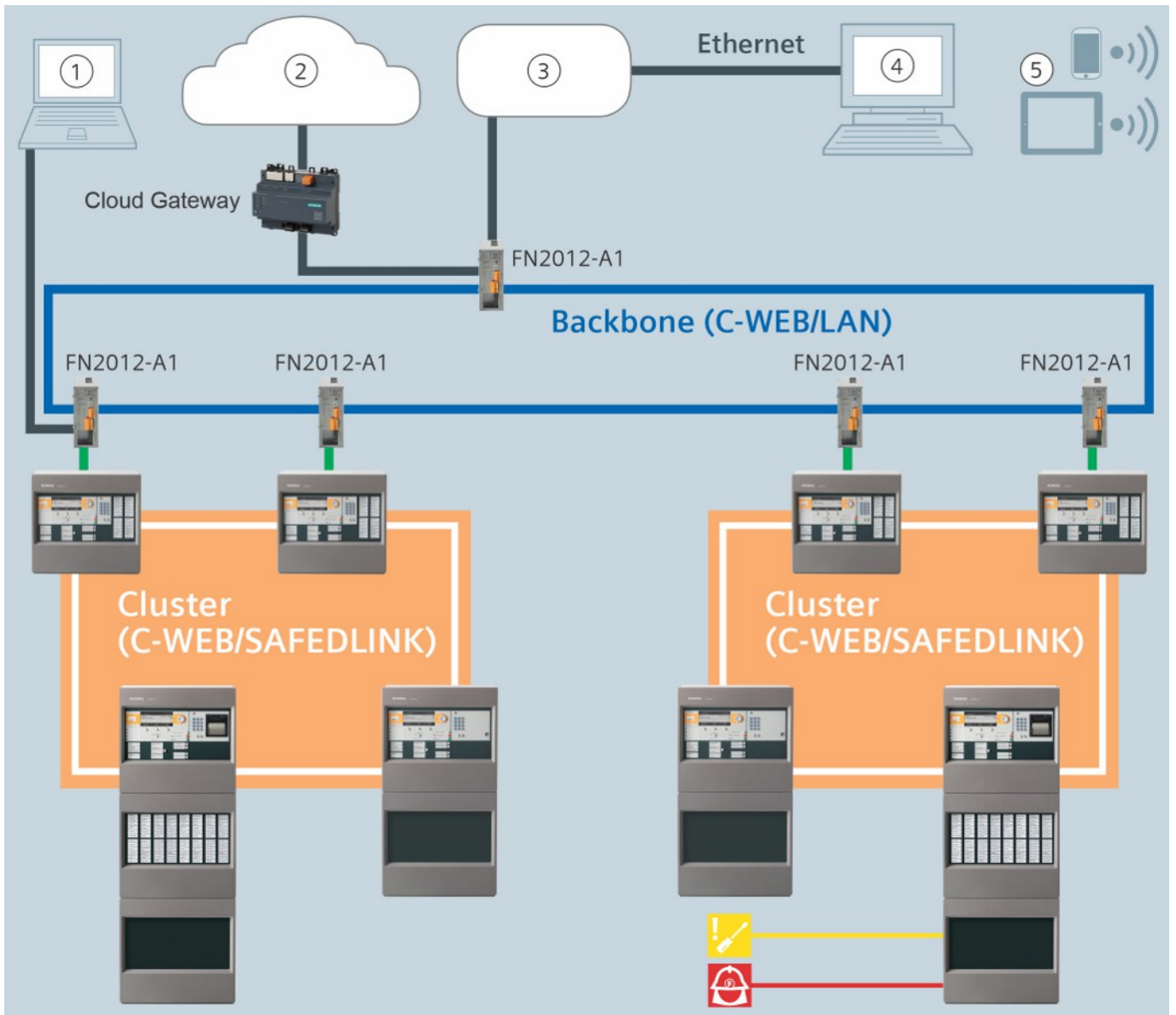



Fig. 4: Backbone

1	Remote access with Cerberus-Remote
2	'Cloud for Buildings'
3	Customer network
4	Management platform
5	Remote access to management platform
	Transmission of a fault signal
	Transmission of an alarm signal

You will find a detailed labeled version of the diagram above along with further information in the A6V10332842 planning guide, see chapter 'Product documentation'.

# Terminal

## General features and functions

- Person Machine Interface that is used remotely from the control panel, which can be optionally provided with its own power supply
- Up to five fire terminals can be configured with system-wide visibility.
- The fire terminal has spaces for installing optional interfaces such as an RS232 or RS485, network modules (SAFEDLINK), and a key switch.
- Each fire terminal has an Ethernet connection.
- The powerful C-WEB can be used to network up to 64 fire control panels FC72x and fire terminals with one another in any way.
- Interface to Siemens danger management system

## Terminal-specific features

FT724-ZZ	Housing (Eco)
	<p>C-NET detector line:</p> <ul style="list-style-type: none"> <li>• None</li> </ul> <p>Features:</p> <ul style="list-style-type: none"> <li>• Operating unit</li> </ul> <p>Station options:</p> <ul style="list-style-type: none"> <li>• 70 W power supply</li> <li>• 2 batteries, each 7 Ah</li> </ul> <p>Operating unit options:</p> <ul style="list-style-type: none"> <li>• Event printer FTO2001-A1</li> <li>• Key switch (Kaba) FTO2005-C1</li> <li>• Key switch (nordic) FTO2006-B1</li> </ul>

## Extensions

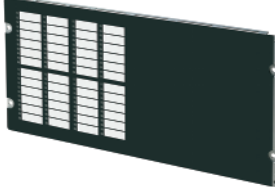
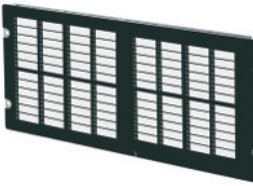
FCM7213-Y3	Operating add-on (2xLED indicator)
	<ul style="list-style-type: none"> <li>• Optional operating add-ons with 48 indicator groups and two LEDs each: 1x red/green LED and 1x yellow LED</li> </ul>
FCM7214-Y3	Operating add-on (4xLED indicator)
	<ul style="list-style-type: none"> <li>• Optional operating add-ons with 96 indicator groups and two LEDs each: 1x red/green LED and 1x yellow LED</li> </ul>

<b>FH7201-Z3</b> 	<b>Housing (Eco)</b> <ul style="list-style-type: none"> <li>• Empty housing for free use</li> <li>• 443 x 404 x 108 mm</li> <li>• E.g., for extra batteries, operating add-ons, or event printers</li> <li>• Space for the following battery configuration: <ul style="list-style-type: none"> <li>– 2x FA2003-A1 (7 Ah)</li> </ul> </li> </ul>
<b>FTO2001-A1</b> 	<b>Event printer</b> <ul style="list-style-type: none"> <li>• Thermal printer for installation in operating units or operating add-ons</li> <li>• Can be controlled via the RS232 module FCA2001-A1 (order separately)</li> <li>• Logs all important events, such as alarms, faults, isolations, and test functions</li> </ul>

# Design

## Function elements

### Operating unit

The following elements are available on the operating unit:

- CPU module and electronics
- Ethernet connection
- Slots for RS232 and RS485 modules and network modules (SAFEDLINK)
- Space for 'Kaba' or 'nordic' key switch

### Fire terminal board

Connection terminals for the following elements are available on the fire terminal board:

- Optional power supply
- 24 V supply from a control panel
- External 24 V power source

### Housing

The housing contains sufficient space for an optional 70 W power supply and 2x batteries with a capacity of 7 Ah.

# Operation

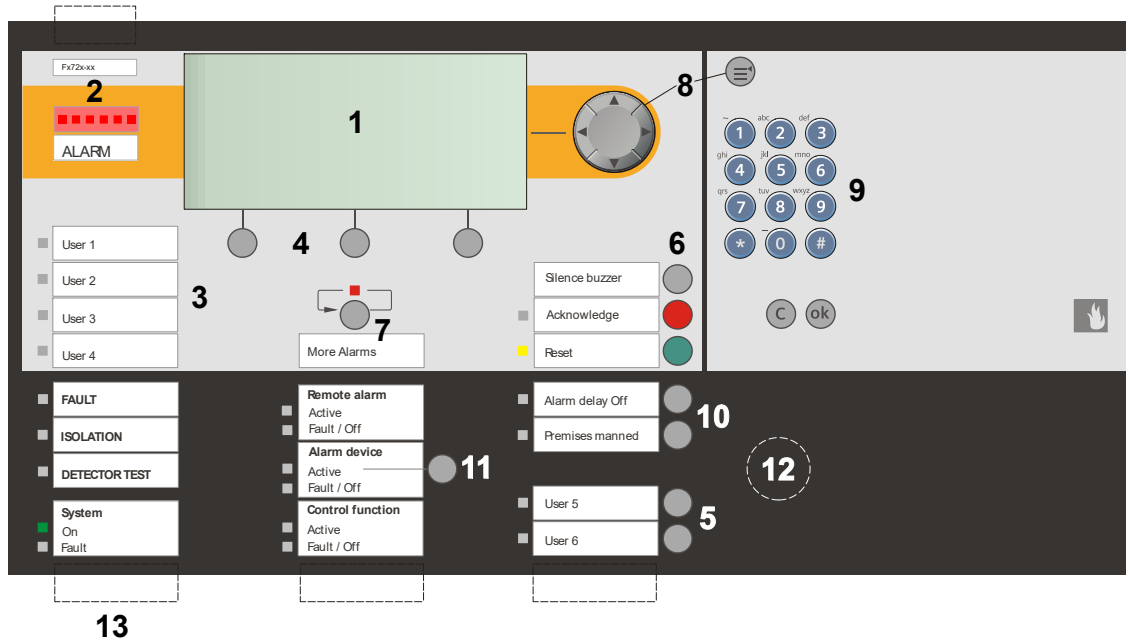

Fig. 5: Indication and operating elements

Position	Comment
1	Backlit 8-line LC display with 40 characters per line and detailed text information about all events that occur: <ul style="list-style-type: none"> <li>• Event type, event location, action texts, operating states</li> <li>• Instructions displayed directly in alarm situations to tell you what to do</li> <li>• Convenient operation via soft keys and navigation button</li> </ul>
2	Alarm indicator, lights up red when an alarm event occurs
3	Four configurable LEDs and associated inscription fields
4	Soft keys for direct operation depending on state
5	Two buttons with LEDs, individually configurable
6	Buttons for 'Buzzer off', 'Acknowledge' message, and 'Reset' message
7	Button for scrolling through alarm messages
8	Navigation and menu buttons
9	Keypad for entering numeric and alphanumeric texts, e.g., password or customer text
10	Alarm organization buttons
11	Button and LEDs with inscription fields for alarming equipment
12	Optional key switch for operating access (Kaba or nordic)
13	Insertable inscription strips

# Setup

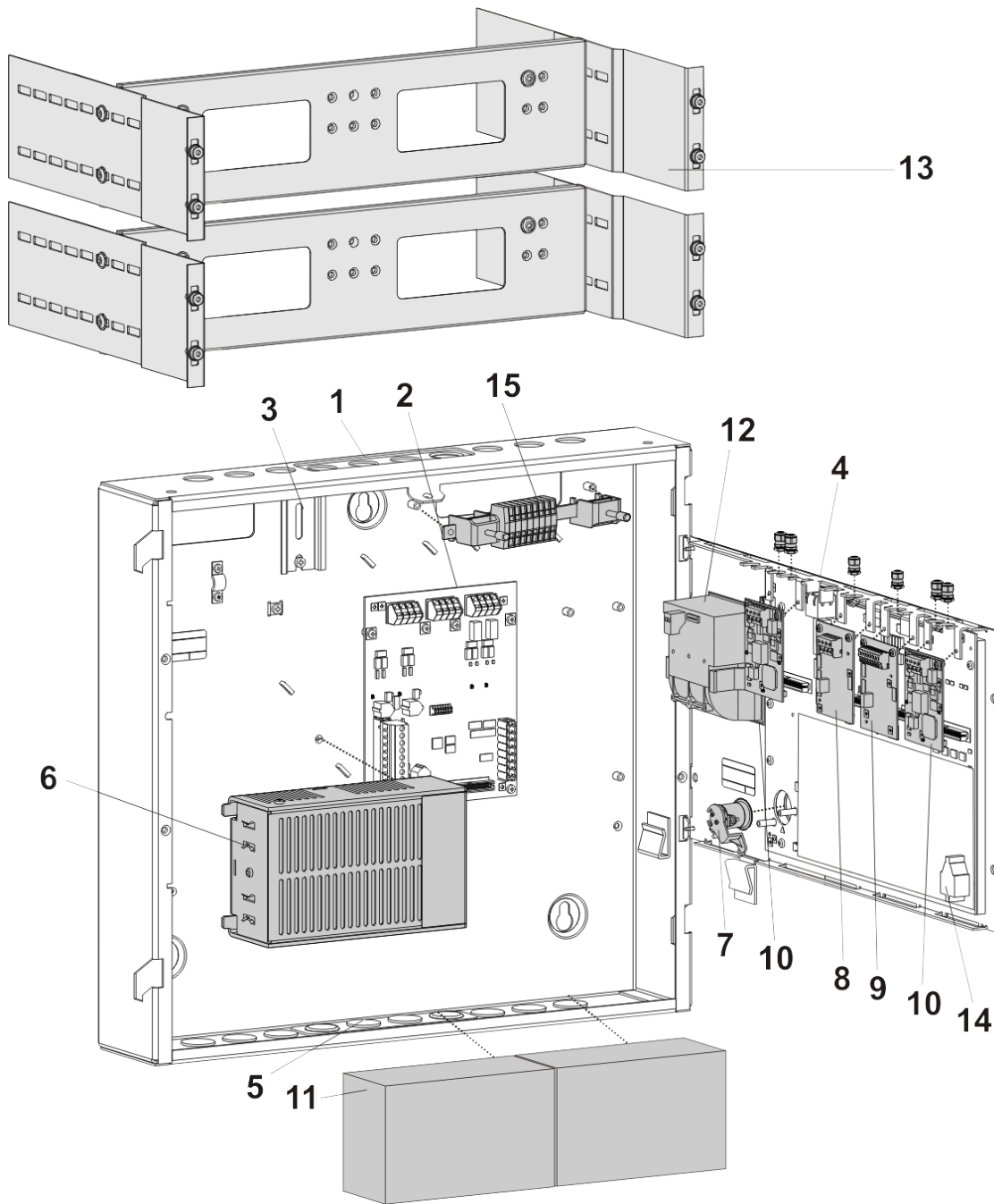



Fig. 6: Layout of FT724

Position	Designation	Type	Comment
<b>Basic equipment</b>			
1	Housing (Eco)	FH7201-Z3	Items 1-5: Basic equipment
2	Fire terminal board	FTI2001-A1	
3	U-rail TS35	-	Space for socket, disconnect terminals
4	Operating unit	FCM7201-Z3	Operating unit with CPU
5	Space for batteries	-	Max. 2x 12 V/7 Ah, optional, with power supply (70 W)
<b>Extensions</b>			
6	Power supply (70 W)	FP2015-A1	If fire terminal is not supplied with power by the control panel

Position	Designation	Type	Comment
7	Key switch (Kaba)	FTO2005-C1	For operating access authorization
	Key switch (nordic)	FTO2006-B1	
8	RS485 module (isolated)	FCA2002-A1	For peripheral devices with RS485 interface
9	RS232 module (isolated)	FCA2001-A1	For devices with an RS232 interface
10	Network module (SAFEDLINK)	FN2001-A1	For networking several stations
11	Battery (12 V, 7 Ah, VdS)	FA2003-A1	For the emergency power supply
12	Event printer	FTO2001-A1	For logging events
13	19" mounting kit	FHA2016-A1	For installation in 19" third-party housing
14	License key Sx	FCA20xx	For special functions
15	Cable kit (communication)	FCA2014-A1	For flexible connections running to the modules on the operating unit

# Type Overview

	Housing (Eco)
	 <p>The image shows the front panel of a Siemens Cerberus FT724-ZZ control unit. It features a color LCD display on the left showing 'All Information' and 'Alarm' status. To the right of the display is a large orange emergency stop button. Further right is a numeric keypad and several indicator lights. Below the keypad are buttons for 'Service Alarm', 'Acknowledge', and 'Reset'. At the bottom, there are sections for 'FAULT', 'ISOLATION', and 'DEFECTIVE TEST' with corresponding status indicators and buttons.</p>
Type	FT724-ZZ
Order number	S54400-C31-A2
Power supply	Without (70 W optional)
Max. battery capacity	7 Ah

# Details for ordering

## Fire terminals

Type	Designation	Weight	Order number
FT724-ZZ	Fire terminal	5.837 kg	S54400-C31-A2

## Extensions

Type	Designation	Weight	Order number
FCA2001-A1	RS232 module (isolated)	0.033 kg	A5Q00005327
FCA2002-A1	RS485 module (isolated)	0.027 kg	A5Q00009923
FCA2014-A1	Cable kit (communication)	0.126 kg	A5Q00023027
FCM7213-Y3	Operating add-on (2xLED indicator)	2.516 kg	S54400-B149-A1
FCM7214-Y3	Operating add-on (4xLED indicator)	3.905 kg	S54400-B150-A1
FH7201-Z3	Housing (Eco)	5.518 kg	S54400-B72-A1
FHA2016-A1	19" mounting kit	3.000 kg	A5Q00020179
FN2001-A1	Network module (SAFEDLINK)	0.022 kg	A5Q00012851
FN2006-A1	Fiber network module (SM)	0.792 kg	S54400-A109-A1
FN2007-A1	Fiber network module (MM)	0.792 kg	S54400-A110-A1
FP2015-A1	Power supply (70 W) for EN-compliant installation in empty housing	1.300 kg	S54400-B121-A1
FTO2001-A1	Event printer	0.141 kg	A5Q00010126
-	Spare printer reels (10 reels)	0.090 kg	A5Q00017619
FTO2005-C1	Key switch (Kaba)	0.083 kg	A5Q00010113
FTO2006-B1	Key switch (nordic)	0.046 kg	A5Q00010129

## Network (backbone)

Type	Designation	Weight	Order number
FCA2031-A1	Connection module (MoNet)	0.081 kg incl. cable	S54400-A153-A1
FHA2029-A1	Mounting kit (switch)	1.261 kg	S54400-B79-A1
FN2012-A1	Ethernet switch (modular)	0.600 kg	S54400-B152-A1
VN2002-A1	Ethernet module (MM)	0.026 kg	S54400-A43-A1
VN2003-A1	Ethernet module (SM)	0.026 kg	S54400-A44-A1

## Battery

Type	Designation	Weight	Order number
FA2003-A1	Battery (12 V, 7 Ah, VdS)	2.350 kg	A5Q00019353
FHA2061-A1	Mounting kit for batteries	–	S54400-B91-A1

## License keys

Type	Designation	Weight	Order number
FCA2033-A1	License key (S1)	0.010 kg	S54400-P154-A1
FCA2034-A1	License key (S2)	0.010 kg	S54400-P155-A1
FCA2035-A1	License key (S3)	0.010 kg	S54400-P156-A1
FCA2036-A1	License key (S4)	0.010 kg	S54400-P157-A1

# Product documentation

Title	Document ID
<b>System documentation</b>	
System description	A6V10210355
Product data	A6V10210368
Planning	A6V10210362
Mounting/Installation	A6V10210390
<b>System data sheet</b>	
FS720 – Fire detection system	A6V10227649
<b>Data sheets</b>	
FC721 - fire control panel	A6V10203220
FC722 - fire control panel	A6V10206525
FC723 - fire control panel for modernization	A6V10379246
FC724 - fire control panel	A6V10207176
FC726 - fire control panel (modular)	A6V10263277
FT724 - fire terminal	A6V10207898
Fire detection system with integrated single-sector extinguishing	A6V11480005
Network Security Guidelines	A6V101039439
Planning overview	A6V10332842

Related documents such as the environmental declarations, declarations of conformity, etc., can be downloaded from the following Internet address:

[www.siemens.com/bt/download](http://www.siemens.com/bt/download)



## Guarantee

Technical data on specific applications are only valid together with Siemens products listed under "Equipment combinations". Siemens rejects any and all warranties in the event that third-party products are used.

# Technical data

Fire terminal FT724		
<b>Supply</b>	Power supply (optional)	70 W
	Operating voltage	DC 20...30 V
	Current consumption at 24 V:	
	• Quiescent current (LCD illumination inactive)	125 mA
	• Alarm current (LCD illumination active)	130 mA
	Max. battery capacity (optional)	2x 12 V, 7 Ah
<b>Inputs / outputs</b>	Supply outputs	2x Vsys
<b>Interfaces</b>	Operating unit	Integrated
	Slots for serial interfaces RS232, RS485	2
	Slots for network modules	2
	Ethernet port RJ45	1
<b>Ambient conditions</b>	Operating temperature	-8...+42 °C
	Storage temperature	-20...+60 °C
	Air humidity (no condensation permitted)	≤95% rel.
	Maximum height above sea level	4000 m
<b>Mechanical data</b>	Dimensions:	
	• Without cover cap	430 x 398 x 85 mm
	• With cover cap	443 x 404 x 108 mm
	Protection category (IEC 60529)	IP30
	Color:	
	• Housing	~RAL 7035
	• Cover cap	~RAL 000 50 00
	• Foil	~RAL 7035, ~RAL 7016
	• Buttons	~RAL 7035, light gray; ~RAL 5014, pigeon blue
<b>Approvals</b>	VdS	G209078
	LPCB	126bn/R02
	FM	3051081