

Cerberus™ PRO / Cerberus™ FIT

Automatic fire detectors

~~OH720~~, ~~OP720~~, ~~HI720~~, ~~HI722~~

Smoke



For the automatically addressable detector bus C-NET

- The ideal fire detector for every application
- Signal processing with detection algorithms
- Address automatically issued during commissioning
- Communication via C-NET (addressed individually)

Features

- Resistant to environmental and interfering influences such as dust, fibers, insects, moisture, extreme temperatures, electromagnetic interference, corrosive vapors, vibration
- Shock resistant, protection against sabotage
- Protected electronics, high-quality components
- Integrated line separator: The defective part on the detector line is located by the fire control panel and isolated between two C-NET devices.
- Integrated alarm indicator (AI), located centrally, 360° visibility
- Up to 2 external alarm indicators type FDAI91/FDAI92/FDAI93 can be connected per detector
- Signal processing with detection algorithms
- Address automatically issued during commissioning
- Same detector base can be used for every detector type, for surface-mounted and recess-mounted supply lines

Eco-friendly

- Environmentally friendly processing
- Reusable materials
- Electronic parts and synthetic materials can be easily separated

Use

OH720 multi-sensor fire detector



Multi-sensor fire detector consisting of:

- Point detector
- Detector dust cap to protect the point detector during the construction phase

Function:

- Functions according to the scattered light principle with one sensor, optical forward scattering
- Opto-electronic measuring chamber which obstructs disruptive extraneous light but provides excellent detection of smoke particles
- An additional heat sensor increases the point detector's immunity to deceptive phenomena
- Selectable detection behavior thanks to two parameter sets
 - Parameter set 1: 'Robust'
 - Parameter set 2: 'Sensitive'
- Immunity to false alarms

Use:

- For detection of flaming fires of solid and liquid substances as well as of smoldering fires
- For reliable fire detection in an environment with deceptive phenomena

OP720 smoke detector



Smoke detector consisting of:

- Point detector
- Detector dust cap to protect the point detector during the construction phase

Function:

- Functions according to the scattered light principle with one sensor, optical forward scattering
- Opto-electronic measuring chamber which obstructs disruptive extraneous light but provides excellent detection of smoke particles
- Selectable detection behavior thanks to two parameter sets
 - Parameter set 1: 'Standard'
 - Parameter set 2: 'Sensitive'

Use:

- For detection of smoke-generating flaming fires and smoldering fires

HI720 heat detector (static and differential)



Heat detector consisting of:

- Point detector with one heat sensor
- Detector dust cap to protect the point detector during the construction phase

Function:

- For high requirements
- Reliable response behavior for slow and rapid temperature rises, plus reliable response behavior for low temperatures
- Selectable detection behavior thanks to two parameter sets
 - Parameter set 1: 'A2S'
 - Parameter set 2: 'A2R'

Use:

- Suitable for rooms with a fluctuating operating temperature
- Where significant dust or dirt deposits or high moisture levels could impair the operation of standard detectors

HI722 heat detector (static only)



Heat detector consisting of:

- Point detector with one heat sensor
- Detector dust cap to protect the point detector during the construction phase

Function:

- Measures the operating temperature. The point detector sends a danger signal to the fire control panel if the maximum temperature is exceeded
- Parameter set: 'A2S'

Use:

- Suitable for rooms with an operating temperature that fluctuates greatly for a short period of time
- Where significant dust or dirt deposits and temperature fluctuations could impair the operation of standard detectors





Intended use

The automatic fire detectors OH720, OP720, HI720, and HI722 may only be used on a C-NET detector line in a FS720 or FC360 fire detection system.

Type Overview

Type	Designation	Order number	Weight [kg]
OH720	Multi-sensor fire detector <ul style="list-style-type: none"> Pure white, RAL 9010 Jet black, RAL 9005 	S54310-F2-A1	0.144
		S54310-F2-A2	
OP720	Smoke detector <ul style="list-style-type: none"> Pure white, RAL 9010 Jet black, RAL 9005 	S54310-F1-A1	0.094
		S54310-F1-A2	
HI720	Heat detector (static and differential)	S54310-F4-A1	0.130
HI722	Heat detector (static only)	S54310-F3-A1	0.130
DB721	Detector base with loop contact <ul style="list-style-type: none"> Pure white, RAL 9010 Jet black, RAL 9005 	S54319-F11-A1	0.052
		S54319-F11-A2	
DB722	Detector base	S54319-F19-A1	0.052
DBS720	Sounder base	S54319-F5-A1	0.090
Accessories			
FDBZ291	Designation plate	A5Q00002621	0.002
FDAI91	Alarm indicator, door frame	S54370-F9-A1	0.020
FDAI92	Alarm indicator, wall version	S54370-F3-A1	0.050
FDAI93	Alarm indicator, built-in version	S54370-F5-A1	0.010
RS720	Detector base seal	S54319-F8-A1	0.012
LP720	Detector locking device (2x Allen keys, 100x set screws)	S54319-F9-A1	0.001
BA720	Base attachment	S54319-F20-A1	0.100
BA721	Base attachment wet	S54319-F29-A1	0.272
DBZ1193A	Designation plate	BPZ:4864330001	0.076
FDBH291	Detector heating unit incl. micro terminal 0.28...0.5 mm ²	A5Q00004439	0.015
DBZ1194	Protective cage	BPZ:4677110001	0.138
DBZ1190-AA	Micro terminal 0.28...0.5 mm ²	BPZ:4677080001	0.001
DBZ1190-AB	Connection terminal 0.5...2.5 mm ²	BPZ:4942340001	0.001
-	Metal cable gland M20 x 1.5	A5Q00004478	0.039

Accessories

Detector base DB721	
	<p>Function:</p> <ul style="list-style-type: none">• Universal base for all point detectors of the Cerberus™ PRO FD720 series <p>Use:</p> <ul style="list-style-type: none">• For recess-mounted supply lines• For surface-mounted supply lines with cables up to max. Ø 8 mm <p>The detector base DB721 has a loop contact. When using the DB721, the detector line is also not interrupted when there is no point detector mounted in the detector base.</p>
Detector base DB722	
	<p>Function:</p> <ul style="list-style-type: none">• Universal base with base seal for point detectors OH720 and OP720 of the Cerberus™ PRO FD720 series <p>Use:</p> <ul style="list-style-type: none">• For recess-mounted supply lines• For surface-mounted supply lines with cables up to max. Ø 8 mm <p>The detector base DB722 has a loop contact. When using the DB722, the detector line is also not interrupted when there is no point detector mounted in the detector base.</p>
Sounder base DBS720	
	<p>Function:</p> <ul style="list-style-type: none">• Addressable sounder base for the acoustic alarm• Compatible with all point detectors from the Cerberus™ PRO FD720 series <p>You will find more information on the sounder base DBS720 in document A6V10218037.</p>
Designation plate FDBZ291	
	<ul style="list-style-type: none">• For labeling with the location address• Can only be used without detector base seal FDBZ295
Detector base seal RS720	
	<ul style="list-style-type: none">• For achieving a higher IP protection category• Mounted between detector base and ceiling

Detector locking device LP720



- For protection against theft of the point detector
- Set screw M3 x 12 mm prevents the point detector being unscrewed from the detector base
- Point detector can only be removed with the appropriate Allen key

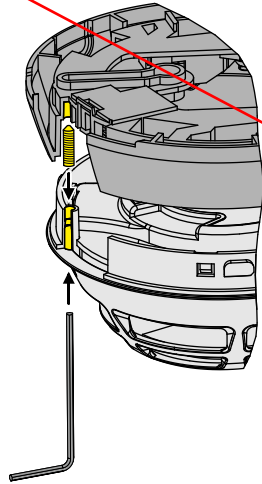

Base attachment BA720



Function:

- For routing surface-mounted ducts (max. 20 mm) and cable ducts (max. 25 x 15 mm)
- Detector base mounted quickly: The detector base clicks into place in base attachment BA720.

Base attachment wet BA721



- Base attachment wet with additional integrated rubber seal for mounting in wet or humid environments
- For achieving a higher protection category
- For mounting in wet or humid environments
- Required when using detector heating unit FDBH291
- Required when using protective cage DBZ1194
- Mounted between detector base and ceiling
- Detector base mounted quickly: The detector base simply clicks into place in base attachment wet BA721.

Designation plate DBZ1193A



- For labeling with the location address
- Can only be used with base attachment wet BA721

Detector heating unit FDBH291



- For operating point detectors in critical ambient conditions during icy conditions or when there is a danger of moisture condensation. Examples of application: Cold stores, attics, loading ramps, cheese cellars
- Optimum function is only guaranteed in conjunction with base attachment wet BA721.
- The point detector temperature increases by approximately 2 °C over the operating temperature and thus avoids moisture condensation on the detector.
- Mounted quickly: The detector heating unit clicks into place in the detector base.

Protective cage DBZ1194

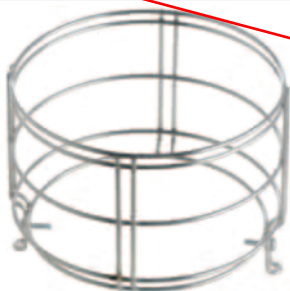

- To protect the point detector from damage
- Can only be mounted in combination with the base attachment humid FDB293 or base attachment wet BA721

DBZ1190-AA micro terminal and DBZ1190-AB connection terminal



- Micro terminal DBZ1190-AA
 - Cable cross section up to max. 0.5 mm²
- Connection terminal DBZ1190-AB
 - Cable cross section up to max. 2.5 mm²
 - For connecting two external alarm indicators or the cable shielding

Installation

- Universal detector base with two break-out points for surface-mounted cable entry at the side. Max. cable diameter: 8 mm.
- Extra-long mounting slits allow existing drill holes from other systems to be reused. Hole spacing 40...90 mm
- Screw terminals for conductors up to 2.5 mm²
- Space for auxiliary terminals:
 - 2x micro terminals DBZ1190-AA and
 - 2x connection terminals DBZ1190-AB
- The internal alarm indicator is centered in the detector, which makes alignment of the point detector superfluous.

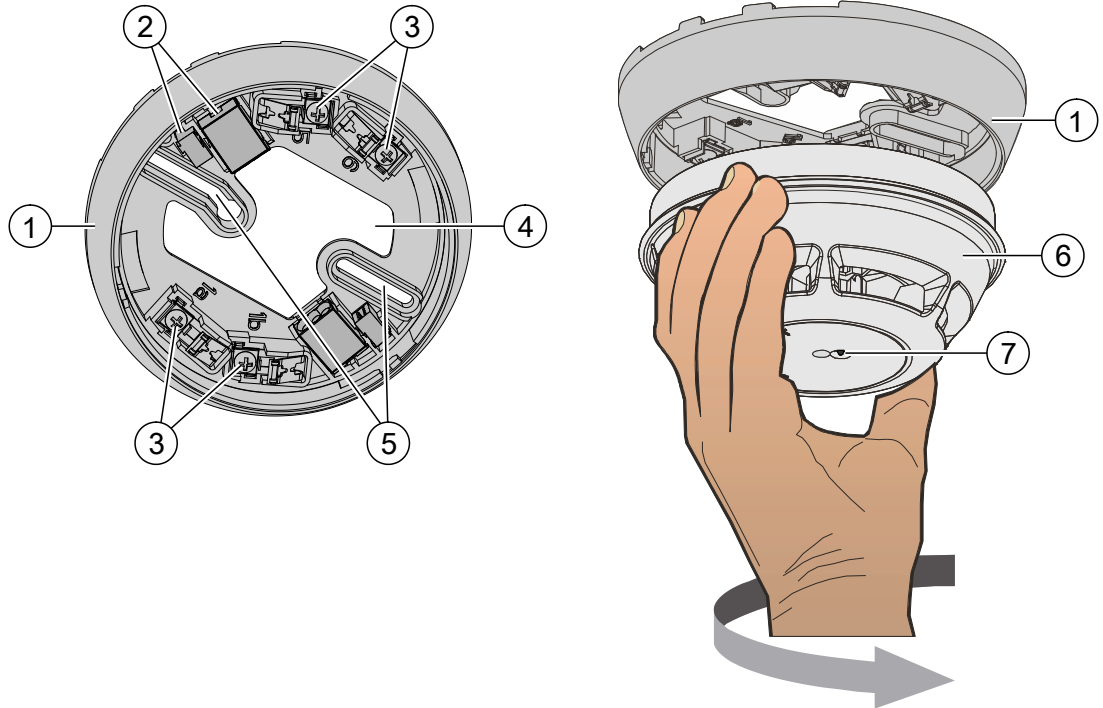

1	Detector base	5	Mounting slits
2	Auxiliary terminals DBZ1190-AA, DBZ1190-AB	6	Point detector
3	Screw terminals for detector line and external alarm indicator	7	Internal alarm indicator
4	Opening for cable entry		

Disposal



The device is considered an electronic device for disposal in accordance with European Directive and may not be disposed of as domestic waste.

- Use only designated channels for disposing the devices.
- Comply with all local and currently applicable laws and regulations.
- Dispose of empty batteries at designated collection points.

Technical data

	OH720	OP720	HI720 / HI722
Operating voltage	DC 12...33 V	DC 12...33 V	DC 12...33 V
Operating current (quiescent)	~230 µA	~220 µA	~200 µA
Max. number of external alarm indicators that can be connected	2	2	2
Operating temperature	-10...+55 °C	-10...+55 °C	-10...+55 °C
Storage temperature	-30...+70 °C	-30...+70 °C	-30...+70 °C
Air humidity (short-term moisture condensation permitted)	≤95 % rel.	≤95 % rel.	≤95 % rel.
Communication protocol	C-NET	C-NET	C-NET
Color	~RAL 9010 pure white ~RAL 9005 jet black	~RAL 9010 pure white ~RAL 9005 jet black	~RAL 9010 pure white
Weight	0.144 kg	0.138 kg	0.130 kg
Protection category (IEC 60529)	IP40	IP40	IP40
Protection category (IEC 60529) with detector base seal RS720	IP42	IP42	IP42
Standards	EN 54-7, EN 54-17, EN 54-29	EN 54-7, EN 54-17	EN 54-5, EN 54-17
Approvals			
• VdS	G209064	G209068	G209065 / G209146
• LPCB	531w/01	531e/01	531f/01 / 531f/02
• FM	3038424	3038424	3037921
• DNV GL (marine)	MEDB00003UK	MEDB00003UK	MEDB00003UR
Permissible wind speed	Max. 5 m/s	Max. 5 m/s	-
C-NET system compatibility	FS720, FC360	FS720, FC360	FS720, FC360

Dimensional drawings

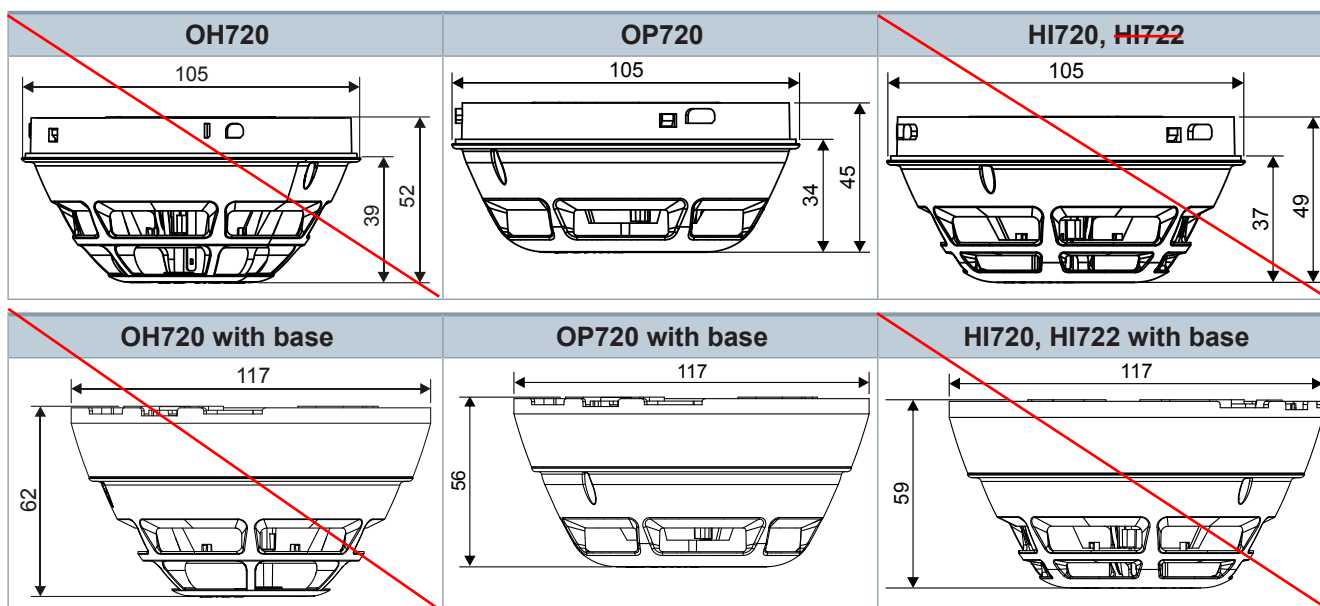

Product documentation

Dokument-ID	Titel
008115	Installation Detector heating FDBH291
A6V10200373	Installation Detector base with loop contact DB721, DB722, detector base DB720, sounder base DBS720, detector base seal RS720, detector locking device LP720, base attachment BA720
A6V10203095	Data sheet Sounder base, Alarm sounders DBS720, FDS221-R, FDS221-W
A6V10203222	Data Sheet Testequipment and accessories FDUL221, DX791, RE6, RE7T, RE8ST, RE8STCO, FDUM29x, LE3, StabexHF
A6V10212047	Technical Manual Automatic fire detectors OH720, OP720, HI720, HI722
A6V10229261	List of compatibility (for 'Cerberus™ PRO' product line)
A6V10393192	List of compatibility (for 'Cerberus™ FIT' product line)
A6V10406006	Installation Base attachment wet BA721, Detector designation plate DBZ1193A, Protective cage DBZ1194, EMC-protective cage FDBZ294

Issued by
Siemens Switzerland Ltd
Smart Infrastructure
Global Headquarters
Theilerstrasse 1a
CH-6300 Zug
+41 58 724 2424
www.siemens.com/buildingtechnologies

© Siemens Switzerland Ltd, 2008
Technical specifications and availability subject to change without notice.

Certificate of Product Approval

Certificate Number: 531e-(cl-1)

Issue: 07

Siemens Switzerland Ltd

Theilerstrasse 1a
CH-6300 Zug
Switzerland



is certified by BRE Global Ltd. and is authorised to use the LPCB mark in association with the product(s) listed in this certificate and appendix having complied with the requirement(s) of the standards as detailed below:

Products

Smoke Detector

OP720

~~OP360~~

(refer to Appendix for details)

Standards

EN 54-7:2018

EN 54-17:2005

This Certificate is maintained and held in force through regular surveillance activities and subject to the corresponding ISO 9001 Certificate being maintained.

Signed for BRE Global Ltd

P Halligan

Verifier

22 February 2022

Date of Issue

4 December 2009

Date of First Issue



This certificate and appendix remains the property of BRE Global Ltd. and is issued subject to terms and conditions (for details visit www.redbooklive.com/terms).

To check the validity of this certificate and appendix please visit www.redbooklive.com/check, scan the QR tag or contact us.

BRE Global Ltd, Watford, WD25 9XX
T: +44 (0)333 321 8811 E: enquiries@breglobal.com

LPCB is a Registered Trademark of the Building Research Establishment Ltd.



Appendix to Certificate No: 531e-(cl-1)

Issue: 07

Siemens Switzerland Ltd

Certified Product	Description	LPCB Ref.No.
OP720	Analogue Addressable Optical Smoke Detector with Short Circuit Isolator (DB720, DB721, DB722 bases, BA720, BA721 base adaptor) Note: 1. Meets the requirements of EN 54-7 in the following sensitivities: - Standard 2.5%/m - Sensitive 1.8%/m	531e/01
OP360	Analogue Addressable Optical Smoke Detector with Short Circuit Isolator (DB720, DB721, DB722 bases, BA720, BA721 base adaptor) Note: 1. Meets the requirements of EN 54-7 in the following sensitivity: - Standard 2.5%/m	531e/04

Bases

- DB720 Detector base
- DB721 Detector base with loop contact
- DB722 Detector base
- BA720 Base adaptor
- BA721 Base adaptor

This Certificate is maintained and held in force through regular surveillance activities and subject to the corresponding ISO 9001 Certificate being maintained.



Signed for BRE Global Ltd

P Halligan

Verifier

22 February 2022

Date of Issue

4 December 2009

Date of First Issue



This certificate and appendix remains the property of BRE Global Ltd. and is issued subject to terms and conditions (for details visit www.redbooklive.com/terms).

To check the validity of this certificate and appendix please visit www.redbooklive.com/check, scan the QR tag or contact us.

BRE Global Ltd, Watford, WD25 9XX
T: +44 (0)333 321 8811 E: enquiries@breglobal.com

LPCB is a Registered Trademark of the Building Research Establishment Ltd.





To Whom It May Concern

Name	Calvin Yeung
Division	Smart Infrastructure
Department	Sales
Telephone	(852) 6312 5070
Fax	(852) 2407 4457
Mobile	(852) 6312 5070
E-mail	calvin.yeung@siemens.com
Internet	www.siemens.com.hk
Your letter of	
Our reference	MF/COO/CP
Date	10 Dec 2025

Dear Sir / Madam,

Re: Country of Origin for “Siemens” Cerberus Pro Automatic Fire Alarm System

Model No.	Description	Country of Origin
FC726	Addressable Fire Alarm Panel	Switzerland
FC724	Addressable Fire Alarm Panel	Switzerland
FC723	Addressable Fire Alarm Panel	Switzerland
FC722	Addressable Fire Alarm Panel	Switzerland
FC721	Addressable Fire Alarm Panel	Switzerland
FT724	Repeater Panel	Switzerland
OP720	Smoke Detector	China
HI720	Heat Detector	China
HI722	Heat Detector	China
OH720	Multi-Sensor Smoke Detector	China
OOHC740 / OOH740	Multi-Sensor Smoke Detector	Switzerland
OOH740-A9-EX	Explosion Proof Smoke / Heat Detector	Switzerland
FDB201	Detector Base	Switzerland
DB721 / DB722	Detector Base	China
FDM221 / FDM231-RP	Manual Call Point	China
FDM225-RP	Manual Call Point	Great Britain
FDM225-RG	Manual Call Point	Great Britain
FDMH295-R	Back Box for MCP	China
FDM226-RP	Manual Call Point Weatherproof	Great Britain
FDM226-RG	Manual Call Point Weatherproof	Great Britain
FDCIO221	Input/ Output Module	China
FDCI221	Input Module	China
FDCI222	Input Module	China
FDCIO222	Input/ Output Module	China
FDCIO223	Input Module for Special Detector(s)	China
FDCH221	Housing for Module	China
FC121-ZA	Conventional Fire Control Panel	China
DCA1192A	Line Coupler	Switzerland
DCB1192A	Terminal Plate	China
FDBH291	Anti-Condensation Heater	China
FDB295	Wet Base	China
DCA1191	Housing	China
STAHL / 9001-00-280-100-101	Safety Barrier	Slovakia
DBS720 / FDSB226	Sounder Base	China
FT2011-A1 / FT2010-A1	Floor Repeater	Switzerland

FDL242	Linear Smoke Detector / Beam Detector	Great Britain
FDLR242	Reflective Prism	Great Britain
FDLRLA242	Reflector for long / short distance	Great Britain
FDF242 / FDF242-EX	Flame Detector	Norway
FDA241	Air Sampling Smoke Detector	Switzerland
FDA261	Air Sampling Smoke Detector	Switzerland
FDCC221S	Communication Interface for FDA241	Switzerland

Should you have any query, please do not hesitate to contact the undersigned at (852) 6312 5070.

Thank you for your kind attention.

Yours faithfully,
Siemens Limited

Calvin Yeung

Digitally signed by
Yeung Wing Fai 
DN: cn=Yeung Wing
Fai, o=DF

Assistant Sales Manager



To Whom It May Concern

Name	Nelson Chow
Division	Smart Infrastructure - Buildings
Department	Sales
Telephone	(852) 9721 6830
Fax	(852) 2407 4457
Mobile	(852) 9721 6830
E-mail	nelson.chow@siemens.com
Internet	www.siemens.com.hk
Your letter of	
Our reference	MF0933/07/NC
Date	15 Dec 2025

Dear Sir / Madam,

Re: Compatible letter for “Siemens” Automatic Fire Alarm System

We write to confirm that “Siemens” FC726 / FC724 / FC723 / FC722 / FC721 Fire Alarm Panel is compatible with OP720, Smoke Detector, OOH740 / OOHC740 Multi-sensor smoke detector, HI720 / HI722 Heat Detector, DBS720 / FDSB226 Sounder Base, FDM231/ FDM225-RP / FDM226-RP Manual Call Point, FDCI221, FDCI222 Input Module, FDCIO221, FDCIO222 Input/ Output Module, FDCIO223 Input Module for Ex-application, OOH740-A9-Ex explosion proof smoke/ heat detector, STAHL 9001/00-280-100-101 safety barrier, FC121-ZA conventional Panel and FT2011-A1 / FT2010-A1 & FT724 repeater.

Should you have any query, please do not hesitate to contact the undersigned at (852) 9721 6830.

Thank you for your kind attention.

Yours faithfully,
Siemens Limited

 Digitally signed by
Chow Siu Wah
Location: Hong
Kong (RC-HK SI
B) by Nelson
Chow

Nelson Chow
Head of V&E Customers Sales
Smart Infrastructure - Buildings

SIEMENS

SIEMENS 'SINTESO / CERBERUS PRO' Addressable AFA System

FC2020/ FC2020-AA/ FC2020-AE/ FC2020-AZ/ FC2020-EZ; FC2030/ FC2030-AA;
FC2040/FC2040-AA/FC2040-AG; FC2060 / FC2060-AA; FC2080; FC721/FC721-ZZ/ FC721-ZA;
FC722 / FC722-ZZ/ FC722-ZA; FC723/ FC723-ZA; FC724/ FC724-ZZ/ FC724-ZA; FC726/
FC726-ZA FS 20 Series Main Fire Alarm Panel
FT2040 / FT724 / FT2011-A1/ FT2010-A1 Repeater Panel
FT2001-A1 Mimic Display Driver
FDOOTC241/ FDOOT241-A/ FDOOT221 / OH720 / OOH740 / OOHC740 Multi-sensor
Detector
OP720 / FDO221/ FDO241 Smoke Detector/ FDT221/ FDT241 / H1720 / H1722 Heat
Detector
FDB222/ DB721/ DB722 Detector Base/ FDSB291 / DBS720 / FDSB226 Sounder Base
FDM231 / FDM221 / FDM225-RG & FDM225-RP (Indoor)/ FDM226-RG & FDM226-RP
(Outdoor) Manual Call Point & FDMH295-R Back Box for MCP
FDCIO221/ FDCI221 / FDCI222/ FDCIO222/ FDCIO223 Input & Output Module

MAJOR JOB REFERENCE (Hong Kong)

Project (Hong Kong)	Client	Date Commenced
Tamar Government Headquarter	Architectural Services Department	02/2008
Tuen Mun Riding School	Hong Kong Jockey Club	03/2008
Toy Story, Hong Kong Disneyland	Hong Kong Government/ Walt Disney	05/2008
Fortune Terrace	Hongfaith Engineering Ltd	06/2008
River Beas Club House	Hong Kong Jockey Club	10/2008
Shatin Racecourse	Hong Kong Jockey Club	10/2008
HAPPY VALLEY RACECOURSE (HVRC) – INFIELD (including Large Video Screen and Indicators)	Hong Kong Jockey Club	10/ 2008
Lai See Industrial Building	Fook Cheong Engineering (HK) Ltd.	03/2009
Temple at Tuen Mun	Kin Ying Contracting Company	03/2009
Aberdeen Ball Club	Aberdeen Ball Club	03/2009

SIEMENS

YoHo Midtown	Sun Hung Kai Properties Ltd.	03/2009
No.32 Chung Hom Kok	Hongfaith Engineering Ltd.'	04/2009
Siu Sai Wan Complex	Architectural Services Department	04/2009
Church at No 18 Cornwall Street	Hongfaith Engineering Ltd	06/2009
East Ocean Centre	Hongfaith Engineering Ltd	06/2009
LaSalle College	LaSalle College	07/2009
235-245 Queen's Road East (Open Kitchen)	Nan Fung Development	07/2009
Mytics, Hong Kong Disneyland	Hong Kong Government/ Walt Disney	08/2009
St. Paul Hospital	St. Paul Hospital	09/2009
Hong Kong Exhibition and Convention Centre	Hong Kong Trade Development Council	10/2009
863-865 King's Road	Kerry Properties Ltd	10/ 2009
Proposed Hotel Development 119-120 Connaught Road, Central	Kin Ying Engineering Ltd	10/ 2009
No. 6 Siu Fai Terrace	Hongfaith Engineering Ltd	10/ 2009
Kee Wah Factory	Kee Wah Group	12/2009
Adventist Hospital, Hong Kong	Adventist Hospital	01/2010
3-5 Star Street	Swire Properties	02/2010
Tong Yan Sun Tsuen	New World Group	02/2010
Primary School at Shek Kip Mei Phase 4	Architectural Services Department	04/2010
Sports Centre in Area 28A Fanling Sheung Shui (SST301)	Architectural Services Department	04/2010
KL 11146 Hoi Fai Road, Kowloon	Sun Hung Kai Properties Ltd.	05/2010
77-85 Bedford Road	Ka Wah International	05/2010
No 24-32 Ming Yuen Western Road	Kowloon Development Co., Ltd.	06/2010
1-3 Victory Avenue. Ho Man Tin	Ka Wah International	06/2010
Substation 207, Infrastructure Expansion,	Hong Kong Government/ Walt Disney	06/2010

SIEMENS

Parkwide, Hong Kong Disneyland

St. Francis Canossian School	St. Francis' Canossian School	06/2010
Park at Tin Shui Wai	Architectural Services Department	06/2010
Tsui Wah Building at No. 51, Lai Yip Street, Kwun Tong	Tsui Wah Restaurant	06/2010
City Hall, Central	Architectural Services Department	06/2010
Li Po Chun United world College	Li Po Chun United World College	06/2010
102F T1 International Trade Centre	Sun Hung Kai Properties Ltd.	07/2010
Li Shu Fan Phase I, The University of Hong Kong	The University of Hong Kong	08/2010
Latitude, San Po Kong	Sun Hung Kai Properties Ltd.	08/2010
Kennedy Town Swimming Pool Phase I	MTRC / Architectural Services Department	09/2010
Infrastructure Expansion, Building 638, Substation 208, Hong Kong Disneyland	Hong Kong Government / Walt Disney	09/2010
Club Siena, Discovery Bay	Hong Kong Resort Company Ltd.	09/2010
Proposed Hotel Development at 2 & 4 Hau Wo Street, Kennedy Town	Kin Ying Contracting Ltd.	10/2010
Proposed Industrial Building at Lop Yip Street & Yip Cheong Street, Fanling	Kin Ying Contracting Ltd.	10/2010
Warehouse, Hong Kong Disneyland	Hong Kong Government/ Walt Disney	10/2010
Nurse Quarters, St Teresa Hospital 20& 22 Lonmond Road	St. Teresa Hospital	10/2010
West Island Line- Reprovision of David Trench Rehabilitation Centre	MTRC/ Architectural Services Department	10/2010
Grizzly Gulch, Hong Kong Disneyland	Hong Kong Government / Walt Disney	11/2010
HKCCCU Logos Academy Extension, TKO	HKCCCU Logos Academy	11/2010
VTC, 145 Pokfulam	Vocational Training Centre	11/2010

SIEMENS

1111 Wuhu Street, Hunghom / Wuhu Residence (Open Kitchen)	Chong's Properties	11/2010
Centennial Campus Phase 1, The University of Hong Kong	The University of Hong Kong	01/2011
Mongkok Dental Clinic	Architectural Services Department	01/2011
Custom & Excise Department Married Staff Quarters at 9-11 Tsing Chau Street	Architectural Services Department	01/2011
International School at Discovery Bay	Shun Hing Contracting Ltd	04/2011
18-36 Shing On Street (Open Kitchen)	Emperor Properties	04/2011
Ma Wan Rural Committee Office	Ma Wan Rural Committee	05/2011
PLK Centenary Li Shiu Chung Memorial College, Tai Hing Estate Tuen Mun	Architectural Services Department	05/2011
PLK Tang Yuk Tien College, Wu King Estate, Tuen Mun	Architectural Services Department	05/2011
Food Inspection Centre, Man Kam Road	Architectural Services Department	05/ 2011
Sunshine City, Ma On Shan	Henderson Real Estate Agency	06/2011
King Ying Street, Kwun Tong	Henderson Real Estate Agency	08/2011
Nin Jiom Medicine Manufacturing Plant	Nin Jiom Medicine	08/2011
Pharmacy Workshop 46 Wang Lee Street, Yuen Long	Private Pharmacy Company	09/2011
1800 Student Hostel, The University of Hong Kong	The University of Hong Kong	10/ 2011
Kowloon City SPSI & 2	Drainage Services Department	10/2011
Yuen Fat Godown	Yuen Fat Fodown	10/2011
Sunshine City Plaza, Ma On Shan	Henderson Real Estate Agency Ltd.	10/2011
No. 21 Tai Tam Road	Liaison Office of the Central	11/2011

	Peoples Government in H.K. SAR	
Residential Development Fuk Wing Street	Chinachem Group	12/2011
CIC-Zero Carbon Building	Hong Kong SAR Government	12/2011
Central Reclamation Phase II	Architectural Services Department	01/2012
Happy Valley Racecourse – Public Stand	The Hong Kong Jockey Club	01/2012
Castle Peak Hospital	Architectural Services Department	02/2012
Ma Wan Hostel	Sun Hung Kai Properties Ltd	02/2012
TKOTL 76 Area 66B	Sun Hung Kai Properties Ltd	04/2012
771B Kennedy Town Station, West Island Line	MTRC	05/2012
Central Wanchai Bypass at Wanchai East	Highway Department	06/2012
Tsing Lung Tao	Sun Hung Kai Properties Ltd	06/2012
Queen Mary Hospital Nurse Quarters	EMSD	06/2012
Prince of Wales Hospital Main Block	EMSD	06/2012
The Peninsula Hotel	The Peninsula Hong Kong	01/2013
The construction of Sports Centre, Community Hall and District Library in Area 148 Shatin	Architectural Services Department	02/2013
11 Jones Street & 11 Warren Street, Tai Hang	Wing Tai Asia	02/2013
New Factory of Maxim's on No 5 Dai Shun Factory Tai Po	Maxim's	02/2013
Engineer's Site Accommodation Po Kong Village Road	Architectural Services Department	02/2013
University Street (Phase 3)	The University of Hong Kong	02/2013
Regal Riverside Hotel	Regal Hotel	03/2013
Tsing Fung Street Hotel	King Ying Contracting Ltd	03/2013



Chow Yei Ching Building	The University of Hong Kong	04/2013
Central Police Station Conservation & Revitalization	Hong Kong Jockey Club	05/2013
Hotel, Queen's Road Central	Sino Properties	07/2013
Hotel, 6 Krusford Terrace	Henderson Land Development Ltd	08/2013
Bright Future Pharmacy Plant, Yuen Long	Bright Future Pharmacy	09/2013
75-81 Sa Po Road	Chinachem Properties	10/2013
110A-110B Argyle Street	Kerry Properties	11/2013
Communication & Technologies Centre, Shatin	Hong Kong Jockey Club	11/2013
Butterfly Hotel, TST	Butterfly Hotel Group	11/2013
Un Chau Street	Chinachem Properties	11/2013
Cheung Sha Residential Bldg	Sino Properties	11/2013
Tin Shui Wai Temp Site Office	Sky Eng	11/2013
3-5 Ede Road	Chinachem Properties	12/2013
TKOTL 76 Area 66C1	Sun Hung Kai Properties	12/2013
Shatin 14B Sport Center	Architectural Services Department	12/2013
TKOL TL39 and Extension	Hongfaith Engineering	01/2014
18-32 Junction Road	Shun Cheong Electrical	01/2014
Block B, St. Paul's Hospital	St. Paul's Hospital	01/2014
Pauline Chan Building	The University of Hong Kong	01/2014
Dept. of Justice Relocation	Architectural Services Department	02/2014
Deep Water Road	Sun Hung Kai Properties	02/2014
New Koala Attraction, Ocean Park	Ocean Park Corporation	03/2014
New Ambulance Depot, Sheung Shui	Architectural Services Department	02/2014
6 Krusford Terrace Hotel	Henderson Land Development	04/2014

SIEMENS

Area 66C1, TKO	Sun Hung Kai Properties Ltd	04/2014
Deep Water Bay Road	Sun Hung Kai Properties Ltd	04/2014
Postgraduate Residence/ Hostel	The University of Hong Kong	05/2014
39-43 Nga Tsin Wai Road	Suen Tat Metal Machine Factory	05/2014
TDS, Disneyland	Hong Kong Government / Walt Disney	06/2014
MTRC1126, Wan Chai Sport Complex	MTRC/ Architectural Services Department	06/2014
Langham Hotel, TST	Langham Hotel	07/2014
21-27A Chatham Road, TST	Joinwell Technical	08/2014
Lot 52, Shatin	Architectural Services Department	10/2014
Castle Peak Hospital	Architectural Services Department	10/2014
Kwong Wah Hospital	Architectural Services Department	10/2014
Patrick Mansion Building (North Wing)	The University of Hong Kong	10/2014
74 Queen's Road Central Hotel	Sino Group	11/2014
Chung On Street, Tsuen Wan	Li's Fire	11/2014
91-103 Parkes Street	Chuang's Consortium Int.	11/2014
42 Wang Lee Street	Productive	11/2014
Maxim's Factory at Tai Po	Maxim's	12/2014
Belvedere Garden Shopping Centre	Belvedere Garden	12/2014
Proposed Hotel at 89-100 Tung Lo Wan Rd	Better Chance International Ltd.	12/2014
Lei Garden Food Factory	Lei Garden Restaurant Group	12/2014
Harbour Road Sports Centre	Leisure & Cultural Services Department	12/2014
TKO Area 66C1 Residential Development	Sun Hung Kai Properties Ltd/ MTRC	01/2015
Heng Seng School of Commerce	Heng Seng School of Commerce	03/2015
Conversion of Senior Staff Quarter at	Architectural Services Department	03/2015

SIEMENS

Mary Hospital

DD331 Cheung Sha	Swire Properties	04/2015
Langham Hotel, TST	Langham Hotel	04/2015
Iron Man Experience, Hong Kong Disneyland	Hong Kong Government/ Walt Disney	06/2015
Heng Sang Bank at Mongkok	Heng Sang Bank	06/2015
Gleneagles HK Hospital	GHK/ New World Development	05/2015
Arts Pavilion, West Kowloon Cultural District	West Kowloon Cultural District	06/2015
MTRC Contract 1123, EXH & Wan Chai Sport Complex	MTRC / Architectural Services Department	06/2015
M+ Museum Mock Up, West Kowloon Cultural District	West Kowloon Cultural District	07/2015
Heng Seng Bank, Arygle Street, Mongkok	Heng Seng Bank	08/2015
Kennedy Town Swimming Pool Phase 2	MTRC / Architectural Services Department	09/2015
18 Pik Sha Street	Chinachem Group	09/2015
TW5 City Side Residential Development	Chinachem Group/ MTRC	12/2015
TW5 Bay Side Residential Development Phase 1	Cheung Kong Holdings Ltd/ MTRC	04/2016
Tak Yip Street, Yuen Long	Sun Hung Kai Properties Ltd	04/2016
Shek Lei Shopping Centre	Housing Authority / The Link	04/2016
Siu Lik Yuen Hotel	Sun Hung Kai Properties Ltd	05/2016
TW5 Bay Side Residential Development Phase 2	Cheung Kong Holdings Ltd/ MTRC	06/2016
35 Baker Road, Peak	Henderson Land	07/2016
Town Lot No.70 Area 86, Site D LOHAS Park, Package 4	Sun Hung Kai Properties Ltd/ MTRC	09/2016
18 & 20 Caine Road	Sun Hung Kai Properties Ltd	10/2016
Caritas Social Centre at	The Catholic Diocese of Hong Kong	10/2016

9 Sheng Mun Road, Tsuen Wan

Hong Kong-Zhuhai-Macao Bridge Hong Kong Link Road Section Between HKSAR Boundary & Scenic Hill	Hong Kong Government	10/2016
The Fleming Hotel Renovation	The Fleming Hotel	11/2016
Proposed Hotel at 33-49, Des Voeux Road	Nan Fung Group	11/2016
Global Switch Data Centre at Tseung Kwan O Industrial Estate Phase 1	Global Switch Hong Kong Limited	11/2016
Wong's Industrial Centre at 180 Wai Yip Street, Kwun Tong	Wong's International Holdings Ltd.	12/2016
House 18, Bisney Crest, 55-57 Bisney Road	Chinachem Group	12/2016
Island Residence 163 Shaukeiwan Road	Wheelock Properties (Hong Kong) Ltd.	12/2016
Haking Wong Building	The University of Hong Kong	12/2016
Proposed Residential Building 565 Kau To Shan	Eco-Green Group Limited	01/2017
Proposed Residential Building 163 Kau To Shan	Eco-Green Group Limited	02/2017
Kwai Chung Hospital Block LM	EMSD	04/2017
MTRC1126 Wan Chai Swimming Pool	MTRC / Architectural Services Department	04/2017
HK-Zhuhai-Macau Bridge Hong Kong Link Road Section Between Scenic Hill and Hong Kong Boundary Crossing Facilities	Hong Kong Government	05/2017
Xiqu Centre	West Kowloon Cultural District	05/2017
17-19 Yik Yam St. Happy Valley	Emperor International Holdings Ltd	06/2017
310 Prince Edward Road West/ Gallant Villa	United Properties Ltd.	06/2017
HK-Zhuhai-Macau Bridge Hong Kong Link Road / PCB	Highways Department	06/2017

SIEMENS

Imperial Cullinan Upgrade	Sun Hung Kai Properties Ltd.	07/2017
8-10 Wong Chuk Hang Road	Swire Properties	07/2017
Lin Fa Kung Street (Site C)	Better Chance International	07/2017
Lin Fa Kung Street (Site D)	Better Chance International	07/2017
Hong Chi Phase 2	Hong Chi Association	09/2017
The West Wing of Central Government Office	Architectural Services Department	10/2017
Butterfly Hotel at Austin Road	Butterfly Hotel	11/2017
Coach Parking for Ocean Park	Ocean Park Corporate	11/2017
68-86 Wang Fung Street	Far East Properties	12/2017
Siu Lik Yuen Hotel	Sun Hung Kai Properties	12/2017
West Kowloon Government Office at Yau Ma Tei	Architectural Services Department	01/2018
TKOTL70 Area 86, Site N, LOHAS Park, Package 6	Nan Fung Group/ MTRC	01/2018
FSSTL225, J/O Luen Hing Street, Fanling	Henderson Land	01/2018
Hong Kong Sanatorium Hospital (Happy Valley)	HK Sanatorium Hospital	03/2018
Global Switch Data Centre at Tseung Kwan O Industrial Estate Phase 2	Global Switch Hong Kong Ltd.	04/2018
TMTL 500 Kwun Chiu Road, Tuen Mun	Evergrande Real Estate	06/2018
OT Block Expansion, Tuen Mun Hospital	Hong Kong Hospital Authority	06/2018
Eastern Medical Centre at 5AKN	Hong Kong Sanatorium Hospital	07/2018
Kings Wing Plaza	Billion Development and Project Management Ltd	07/2018
Primary School at Anderson Road, Kwun Tong	Architectural Services Department	09/2018
6-22 Chung Ching Street	Henderson Land Group	10/2018
Stubb Road	Sun Hung Kai Properties Ltd	12/2018

HK Airport Contract 3712 – New Project Site Office	The Airport Authority Hong Kong	12/2018
KGO Pumpcell at West Kowloon Cultural Centre	West Kowloon Cultural District Authority	12/2018
EP, Panda Café & AAA, Ocean Park	Ocean Park Corporation	12/2018
Hing Hon Road	Kerry Properties Limited	01/2019
A New Club House at Shan Kwong Road	Hong Kong Jockey Club	01/2019
Ki Lung Street	Henderson Land	01/2019
Lai King Workshop	Architectural Services Department	01/2019
Chun Yip Street Market	Architectural Services Department	01/2019
1-11 Kwai Hei Street	Henderson Land	02/2019
411 Catham Road North	Henderson Land	02/2019
A Boy School in Area 28 Tuen Mun	Architectural Services Department	03/2019
No. 106 Yip Wong Road Tuen Mun Lot. No. 514	Henderson Land Development Company Limited	03/2019
The Arch, Kowloon Station	Sun Hung Kai Properties Ltd	03/2019
Residential Dev. TKOTL70 Site	Cheung Kong (Holdings) Limited/ MTRC	03/2019
180-184 Shau Kei Wan Road	EASE Day Limited	04/2019
Vehicle Exam Centre Tsing Yi	Transport Department	04/2019
Tai Wai Station STTL No.52	New World Development Co Ltd/ MTRC	04/2019
STTL601 Yiu Sha Rd, Ma On Shan	Country Garden (Hong Kong) Ltd	05/2019
Tuen Mun Hospital New OT Blk Extension	Hong Kong Hospital Authority	06/2019
Medical Complex Extension	The University of Hong Kong	06/2019
Shek Wu Hui Sewage Treatment Work	Drainage Services Department, HKSAR	07/2019
68-70 Electric Road	Success Seeker Limited	07/2019

SIEMENS

Ocean Park Waterfront	Ocean Park Corporation	07/2019
Eastern Medical Centre at 3AKN	Hong Kong Sanatorium Hospital	07/2019
Castle, Hong Kong Disneyland	Hong Kong International Theme Parks Ltd	08/2019
Grandstand South & Training Pool, South China Athletic Association	South China Athletic Association	08/2019
Fu Shan Public Mortuary	Architectural Services Department	08/2019
TMTL500, Kwun Chiu Road, Tuen Mun	China Evergrande Group	08/2019
Global Switch HK1 Building 4 & 5	Global Switch Hong Kong Limited	09/2019
Win Plaza	Henderson Land Development Company Limited	09/2019
CLP Black Point Power Station D1	CLP Power Hong Kong Ltd.	09/2019
HKSTP Innocell Residential Institution	Hong Kong Science Park	11/2019
Inland Revenue Tower	Architectural Services Department	12/2019
33 Tin Shui Wai, Yuen Long	Sun Hung Kai Properties Ltd	12/2019
YOHO Hub at Yuen Long Station	Sun Hung Kai Properties Ltd/ MTRC	12/2019
Kwai Chung Hospital Phase 2	Hospital Authority	12/2019
Area 54, Siu Hong, Tuen Mun	Sun Hung Kai Properties Ltd	02/2020
Arendelle, Hong Kong Disneyland	HK International Theme Parks Ltd	02/2020
Regal TST Hotel	Regal Hotel Group	02/2020
APIL136, Ap Lei Chau	Unicorn Bay (HK) Investment Ltd	02/2020
Christian Zheng Sheng College	Christian Zheng Sheng College	02/2020
IE2.0, Advanced Manufacturing Centre, TKO	Hong Kong Science Park	03/2020
Tai Po Town Lot 223 & 229	HKR International Limited	03/2020
Town Lot 33, Area 112, Tin Shui Wai	Sun Hung Kai Properties Ltd.	03/2020

SIEMENS

Butterfly on Prat Boutique Hotel at Tsim Sha Tsui	Butterfly on Prat Boutique Hotel	05/2020
HKAA 3722 Third Runway Site Office	Airport Authority	06/2020
Queen Mary Hospital	Architectural Services Department	06/2020
Penny Bay Phase 2	Architectural Services Department	07/2020
A 30 Classroom primary school at Tokin Street, Cheung Sha Wan	Architectural Services Department	08/2020
Whisker Harbour, Ocean Park	Ocean Park Corporation	10/2020
Penny's Bay Phase 3A	Architectural Services Department	10/2020
Penny's Bay Phase 3B	Architectural Services Department	10/2020
Penny's Bay Phase 4	Civil Engineering and Development Department	11/2020
Adventure Land, Ocean Park	Ocean Park Corporation	11/2020
VAC System for Inland Revenue Tower	Architectural Services Department	11/2020
Second Expansion of DHL Central Asia Hub	DHL Express Hong Kong Ltd.	12/2020
Queen Elizabeth Hospital	Electrical and Mechanical Services Department	12/2020
NKIL6550 Cheung Sha Wan Hotel	Sun Hung Kai Properties Ltd	01/2021
Prince of Wales Hospital - Main Block – H, K, L, & M and Special Block – E & F	Hospital Authority	01/2021
NKIL6582 Cheung Sha Wan Office	New World Development	02/2021
No. 43 Island Road	Chong Hing Bank Limited	02/2021
HKIA C3723 Third Runway Eastern Support Area	Hong Kong International Airport	03/2021
Proposed New Dangerous Goods Store, The Chinese University of Hong Kong	The Chinese University of Hong Kong	03/2021
136 Lei Nam Road & 232 Wan Chai Road	Logan Property Holdings Limited	03/2021
Shopping Centre at Elizabeth House	Cheung Kong Property Holdings Limited	03/2021

Elderly Centre at Ventris Road	Hong Kong Macau Conference Holding Limited	03/2021
To Shek Street, Shatin	Sun Hung Kai Properties Ltd	03/2021
IT Operations Building at Shatin Racecourse	The Hong Kong Jockey Club	03/2021
Good Hope School at Hei Fook Road	Good Hope School	04/2021
Regency Centre 1&2 at 41-43 Wong Chuk Hang Road	Ever Success Holdings Ltd	04/2021
41 King Yip Street, Kwun Tong	Viva Properties Development Limited	04/2021
Kai Tak Sports Park	Architectural Services Department /New World Development	05/2021
C&E Dept at No. 57 Sheung Fung Street, Wong Tai Sin	Architectural Services Department	06/2021
New Academic Building at St. Stephen's College at Stanley	St. Stephen's College	07/2021
Light Rail Tin Wing Stop, Area 33	Sun Hung Kai Properties Ltd/ MTRC	07/2021
NKIL6551 Kai Tak	Sun Hung Kai Properties Ltd	08/2021
Transitional Housing Development at Kong Ha Wai, Kam Tin	Pok Oi Hospital	10/2021
Kwu Tau North Development Area	Civil Engineering and Development Department	12/2021
Summit, Ocean Park	Ocean Park Corporation	12/2021
The Cliveden	Kerry Properties Limited	01/2022
Prince of Wales Hospital - Clinical Sciences Building, Trauma Centre & A/C Room at Prince of Wales Hospital	Hospital Authority	01/2022
Kai Tak Area 4C site 3, NKIL 6551	Sun Hung Kai Properties Ltd	01/2022
Hotel Development at 62 -68 Chun Yeung Street, North Point	Vanke Property Agency Limited	01/2022
Jockey Club One Health Tower and A&A works for Academic Exchange Building at City University Lodge	City University of Hong Kong	02/2022

Proposed T.W.G. Hs Holistic Centre for youth Development at San Po Kong	Tung Wah Group of Hospitals	03/2022
Design & Construction of Immigration Headquarters in Area 67, Tseung Kwan O	Architectural Services Department	03/2022
Kai Tak Isolation Facilities	Architectural Services Department	03/2022
Siu Sai Wan Health Centre	Architectural Services Department	03/2022
RCP at Hung Yuen Road	Architectural Services Department	03/2022
36 Wong Chuk Hang Road	Empire Group Ltd	03/2022
22 Wang Yip Street West	Star Properties HK Ltd.	04/2022
Proposed Office Development at 2 Murray Road, Central	Henderson Land	04/2022
Shui On Centre	Shui On Centre	05/2022
Light Rail in Ting Wing Stop, TSWTL No. 23 Area 33, Tin Shui Wai	Sun Hung Kai Properties Ltd	05/2022
7-9A Cheung Wah Street	Well Century Investments Ltd	05/2022
LOHAS 11 at TKO	Sino Land/ MTRC	06/2022
14 Wang Tai Road	First Group Holdings Ltd	06/2022
918 Cheung Sha Wan Road	First Group Holdings Ltd	06/2022
926 Cheung Sha Wan Road	First Group Holdings Ltd	06/2022
Nexus Building	Jones Lang LaSalle, Inc.	06/2022
Multi-welfare Services Complex in Kwu Tung North	Architectural Services Department	06/2022
Community Health Centre and Social Welfare Facilities Building in Siu Sai Wan	Architectural Services Department	07/2022
Shui On Centre	Socam Development Ltd	07/2022
Hong Kong Baptist University	Hong Kong Baptist University	07/2022

SIEMENS

Lyric Theatre Complex	West Kowloon Cultural District	08/2022
The Communal, Lyric Theatre Complex	West Kowloon Cultural District	09/2022
Proposed Office Buildings & shopping mall at KIL 11262 West Kowloon Station	Sun Hung Kai Properties Ltd	10/2022
CLP Black Point Power Station, D2	CLP Power Hong Kong Ltd.	10/2022
West Kowloon Express Railway Link Terminus Commercial Development	Sun Hung Kai Properties	10/2022
37-43 Sha Tsui Road, Tsuen Wan	RealPlus Property Company Limited	10/2022
The Student Residence at Wong Chuk Hang Site, The University of Hong Kong	The University of Hong Kong	11/2022
Proposed Transitional Housing at Wong Yue Tang & Luen Yan Street	The Lok Sin Tong Benevolent Society, Kowloon	11/2022
Immigration Centre, Tseung Kwan O	Immigration Department	11/2022
Proposed Commercial Buildings at No. 7 Lai Yip Street, Kwun Tong	Henderson Land Development Co., Ltd	12/2022
Redevelopment of Kwai Chung Hospital (Phase 2)	Architectural Services Department	12/2022
Prince of Wales Hospital - Li Ka Shing Medical Sciences Building	Hospital Authority	01/2023
Hospital Authority Supporting Services Centre in North Lantau	Hospital Authority	01/2023
Proposed Residential Buildings at Yau Tong Lot 45	Cheung Kong Property Holdings Ltd	02/2023
Upgrade of AFA system at Marine World, Ocean Park	Ocean Park Corporation	03/2023
Proposed Residential Building at YOHO Hub	Sun Hung Kai Properties Ltd	04/2023
Proposed Office Buildings at 14 Wang Tai Road, Kowloon Bay	First Group Holdings Ltd	04/2023
Central Kowloon Route - Yau Ma Tei East	Highways Department	05/2023
Proposed Residential Development at Kai Tak Area 4C, Site 3	Sun Hung Kai Properties Ltd	05/2023

SIEMENS

Proposed Office Development AIA Tower	AIA International Ltd	05/2023
Proposed Residential Building at LOHAS 11, Tseung Kwan O	Sino Land Company Ltd	06/2023
Proposed Residential Building at Tai Wai Station	New World Development Co., Ltd	06/2023
Transitional Housing Project at DD106 Ngau Tam Mei, Yuen Long	Evangelical Lutheran Church Social Service Hong Kong	07/2023
Proposed residential Buildings at 53 Kwun Tong Road, Kwun Tong	One Link International Holdings, W. S. H. Group	07/2023
Transitional Housing Project at Ping Che Road, Ta Kwu Ling	Pok Oi Hospital	07/2023
Proposed Office Building at 20 Des Voeux Road, Central	Tak Shing Investment Co Ltd	08/2023
Proposed Data Centre at Chai Wan Kok Street & Ma Wo Road	Goodman Aisa Ltd	08/2023
High West Development, The University of Hong Kong	The University of Hong Kong	09/2023
Contract No. DE/201/04 Shek Wu Hui Effluent Polishing Plant - Main Works Stage 1	Drainage Services Department	10/2023
VAC / SPS for GTWW Building 2 & 8, 23-33 Chai Wan Kok Street, Tsuen Wan	Goodman GTWW Investment No. 2 Ltd	11/2023
The Avignon	Sun Hung Kai Properties Ltd	11/2023
No. 6602 Ko Chiu Road, Yau Tong, Kowloon	Sino Land Co., Ltd	12/2023
VAC for Hospital Authority Supporting Services Centre in North Lantau	Hospital Authority	01/2024
Chinese Medicine Hospital	Health Bureau	01/2024
Proposed Residential Development at Discovery Bay Area N1 North	HKR International Ltd	02/2024
Proposed Residential Building at Tai Po	Vanke Holdings (HK) Co., Ltd	02/2024

Town Lot 243

Tung Chung Valley Phase 1	Civil Engineering and Development Department	03/2024
Government Chinese Medicines Testing Institute in TKO	Chinese Medicine Regulatory Office	03/2024
Contract No. EM2003: Central Kowloon Route - Yau Ma Tei West	Highways Department	03/2024
Block BC, Block DE & Block F, Kwai Chung Hospital	Hospital Authority	04/2024
Temporary Transitional Housing Development at D.D. 128 & D.D. 129 and Adjoining Government Land, Lau Fau Shan, Yuen Long	Tung Wah Group of Hospital	05/2024
Joint-User Government Office Building in Area 67, TKO	Architectural Services Department	05/ 2024
Proposed Commercial Development on IL No. 8945 at Caroline Hill Road, Causeway Bay	Hysan Properties Ltd	06/ 2024
Waterfront Area, Ocean Park	Ocean Park Corporation	07/2024
Proposed Hong Kong Polytechnic University - Student Hostel at Tat Hong Avenue, Kowloon Tong	Hong Kong Polytechnic University	08/ 2024
Light Public Housing at Zone 1 & Zone 2 - Yau Pok Road, Phase 1 & Phase 2 - Choi Hing Road, Tuen Mun Area 3A	Architectural Services Department	09/ 2024
Proposed Residential Development at Tong San Tsuen, Yuen Long	Architectural Services Department	10/ 2024
Ventilation & Air Conditioning System Kai Tak Acute Hospital (Site B)	Architectural Services Department	10/ 2024
Transitional Housing at Shuen Wan, Off Ting Kok Road, Tai Po, N. T.	The Society of Rehabilitation and Crime Prevention, Hong Kong	11/ 2024
Design & Construction of the District Court at Caroline Hill Road	Architectural Services Department	11/ 2024
Science Park Expansion Stage 2 Building	Science Park	12/ 2024
Open space with Public Vehicle Park at Yen Chow Street West	Architectural Services Department	12/ 2024

SIEMENS

Kai Tak Acute Hospital (Site A)	Architectural Services Department	01/ 2025
Hong Kong International Arbitration Centre (The Headquarters for an International Organization)	Architectural Services Department	01/ 2025