

Cerberus™ PRO / Cerberus™ FIT

Automatic fire detectors

~~OH720~~, ~~OP720~~, HI720, ~~HI722~~

Heat



For the automatically addressable detector bus C-NET

- The ideal fire detector for every application
- Signal processing with detection algorithms
- Address automatically issued during commissioning
- Communication via C-NET (addressed individually)

Features

- Resistant to environmental and interfering influences such as dust, fibers, insects, moisture, extreme temperatures, electromagnetic interference, corrosive vapors, vibration
- Shock resistant, protection against sabotage
- Protected electronics, high-quality components
- Integrated line separator: The defective part on the detector line is located by the fire control panel and isolated between two C-NET devices.
- Integrated alarm indicator (AI), located centrally, 360° visibility
- Up to 2 external alarm indicators type FDAI91/FDAI92/FDAI93 can be connected per detector
- Signal processing with detection algorithms
- Address automatically issued during commissioning
- Same detector base can be used for every detector type, for surface-mounted and recess-mounted supply lines

Eco-friendly

- Environmentally friendly processing
- Reusable materials
- Electronic parts and synthetic materials can be easily separated

Use

OH720 multi-sensor fire detector



Multi-sensor fire detector consisting of:

- Point detector
- Detector dust cap to protect the point detector during the construction phase

Function:

- Functions according to the scattered light principle with one sensor, optical forward scattering
- Opto-electronic measuring chamber which obstructs disruptive extraneous light but provides excellent detection of smoke particles
- An additional heat sensor increases the point detector's immunity to deceptive phenomena
- Selectable detection behavior thanks to two parameter sets
 - Parameter set 1: 'Robust'
 - Parameter set 2: 'Sensitive'
- Immunity to false alarms

Use:

- For detection of flaming fires of solid and liquid substances as well as of smoldering fires
- For reliable fire detection in an environment with deceptive phenomena

OP720 smoke detector



Smoke detector consisting of:

- Point detector
- Detector dust cap to protect the point detector during the construction phase

Function:

- Functions according to the scattered light principle with one sensor, optical forward scattering
- Opto-electronic measuring chamber which obstructs disruptive extraneous light but provides excellent detection of smoke particles
- Selectable detection behavior thanks to two parameter sets
 - Parameter set 1: 'Standard'
 - Parameter set 2: 'Sensitive'

Use:

- For detection of smoke-generating flaming fires and smoldering fires

HI720 heat detector (static and differential)



Heat detector consisting of:

- Point detector with one heat sensor
- Detector dust cap to protect the point detector during the construction phase

Function:

- For high requirements
- Reliable response behavior for slow and rapid temperature rises, plus reliable response behavior for low temperatures
- Selectable detection behavior thanks to two parameter sets
 - Parameter set 1: 'A2S'
 - Parameter set 2: 'A2R'

Use:

- Suitable for rooms with a fluctuating operating temperature
- Where significant dust or dirt deposits or high moisture levels could impair the operation of standard detectors

HI722 heat detector (static only)



Heat detector consisting of:

- Point detector with one heat sensor
- Detector dust cap to protect the point detector during the construction phase

Function:

- Measures the operating temperature. The point detector sends a danger signal to the fire control panel if the maximum temperature is exceeded
- Parameter set: 'A2S'

Use:

- Suitable for rooms with an operating temperature that fluctuates greatly for a short period of time
- Where significant dust or dirt deposits and temperature fluctuations could impair the operation of standard detectors





Intended use

The automatic fire detectors OH720, OP720, HI720, and HI722 may only be used on a C-NET detector line in a FS720 or FC360 fire detection system.

Type Overview

| Type | Designation | Order number | Weight [kg] |
|--------------------|---|--------------------------------|-------------|
| OH720 | Multi-sensor fire detector <ul style="list-style-type: none"> Pure white, RAL 9010 Jet black, RAL 9005 | S54310-F2-A1 S54310-F2-A2 | 0.144 |
| OP720 | Smoke detector <ul style="list-style-type: none"> Pure white, RAL 9010 Jet black, RAL 9005 | S54310-F1-A1 S54310-F1-A2 | 0.094 |
| HI720 | Heat detector (static and differential) | S54310-F4-A1 | 0.130 |
| HI722 | Heat detector (static only) | S54310-F3-A1 | 0.130 |
| DB721 | Detector base with loop contact <ul style="list-style-type: none"> Pure white, RAL 9010 Jet black, RAL 9005 | S54319-F11-A1 S54319-F11-A2 | 0.052 |
| DB722 | Detector base | S54319-F19-A1 | 0.052 |
| DBS720 | Sounder base | S54319-F5-A1 | 0.090 |
| Accessories | | | |
| FDBZ291 | Designation plate | A5Q00002621 | 0.002 |
| FDAI91 | Alarm indicator, door frame | S54370-F9-A1 | 0.020 |
| FDAI92 | Alarm indicator, wall version | S54370-F3-A1 | 0.050 |
| FDAI93 | Alarm indicator, built-in version | S54370-F5-A1 | 0.010 |
| RS720 | Detector base seal | S54319-F8-A1 | 0.012 |
| LP720 | Detector locking device (2x Allen keys, 100x set screws) | S54319-F9-A1 | 0.001 |
| BA720 | Base attachment | S54319-F20-A1 | 0.100 |
| BA721 | Base attachment wet | S54319-F29-A1 | 0.272 |
| DBZ1193A | Designation plate | BPZ:4864330001 | 0.076 |
| FDBH291 | Detector heating unit incl. micro terminal 0.28...0.5 mm ² | A5Q00004439 | 0.015 |
| DBZ1194 | Protective cage | BPZ:4677110001 | 0.138 |
| DBZ1190-AA | Micro terminal 0.28...0.5 mm ² | BPZ:4677080001 | 0.001 |
| DBZ1190-AB | Connection terminal 0.5...2.5 mm ² | BPZ:4942340001 | 0.001 |
| - | Metal cable gland M20 x 1.5 | A5Q00004478 | 0.039 |

Accessories

| | |
|---|--|
| Detector base DB721 | |
|  | <p>Function:</p> <ul style="list-style-type: none">• Universal base for all point detectors of the Cerberus™ PRO FD720 series <p>Use:</p> <ul style="list-style-type: none">• For recess-mounted supply lines• For surface-mounted supply lines with cables up to max. Ø 8 mm <p>The detector base DB721 has a loop contact. When using the DB721, the detector line is also not interrupted when there is no point detector mounted in the detector base.</p> |
| Detector base DB722 | |
|  | <p>Function:</p> <ul style="list-style-type: none">• Universal base with base seal for point detectors OH720 and OP720 of the Cerberus™ PRO FD720 series <p>Use:</p> <ul style="list-style-type: none">• For recess-mounted supply lines• For surface-mounted supply lines with cables up to max. Ø 8 mm <p>The detector base DB722 has a loop contact. When using the DB722, the detector line is also not interrupted when there is no point detector mounted in the detector base.</p> |
| Sounder base DBS720 | |
|  | <p>Function:</p> <ul style="list-style-type: none">• Addressable sounder base for the acoustic alarm• Compatible with all point detectors from the Cerberus™ PRO FD720 series <p>You will find more information on the sounder base DBS720 in document A6V10218037.</p> |
| Designation plate FDBZ291 | |
|  | <ul style="list-style-type: none">• For labeling with the location address• Can only be used without detector base seal FDBZ295 |
| Detector base seal RS720 | |
|  | <ul style="list-style-type: none">• For achieving a higher IP protection category• Mounted between detector base and ceiling |

Detector locking device LP720



- For protection against theft of the point detector
- Set screw M3 x 12 mm prevents the point detector being unscrewed from the detector base
- Point detector can only be removed with the appropriate Allen key

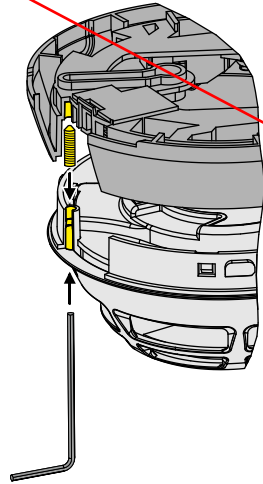

Base attachment BA720



Function:

- For routing surface-mounted ducts (max. 20 mm) and cable ducts (max. 25 x 15 mm)
- Detector base mounted quickly: The detector base clicks into place in base attachment BA720.

Base attachment wet BA721



- Base attachment wet with additional integrated rubber seal for mounting in wet or humid environments
- For achieving a higher protection category
- For mounting in wet or humid environments
- Required when using detector heating unit FDBH291
- Required when using protective cage DBZ1194
- Mounted between detector base and ceiling
- Detector base mounted quickly: The detector base simply clicks into place in base attachment wet BA721.

Designation plate DBZ1193A



- For labeling with the location address
- Can only be used with base attachment wet BA721

Detector heating unit FDBH291



- For operating point detectors in critical ambient conditions during icy conditions or when there is a danger of moisture condensation. Examples of application: Cold stores, attics, loading ramps, cheese cellars
- Optimum function is only guaranteed in conjunction with base attachment wet BA721.
- The point detector temperature increases by approximately 2 °C over the operating temperature and thus avoids moisture condensation on the detector.
- Mounted quickly: The detector heating unit clicks into place in the detector base.

Protective cage DBZ1194

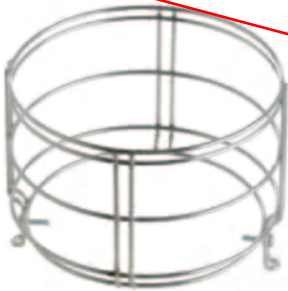

- To protect the point detector from damage
- Can only be mounted in combination with the base attachment humid FDB293 or base attachment wet BA721

DBZ1190-AA micro terminal and DBZ1190-AB connection terminal



- Micro terminal DBZ1190-AA
 - Cable cross section up to max. 0.5 mm²
- Connection terminal DBZ1190-AB
 - Cable cross section up to max. 2.5 mm²
 - For connecting two external alarm indicators or the cable shielding

Installation

- Universal detector base with two break-out points for surface-mounted cable entry at the side. Max. cable diameter: 8 mm.
- Extra-long mounting slits allow existing drill holes from other systems to be reused. Hole spacing 40...90 mm
- Screw terminals for conductors up to 2.5 mm²
- Space for auxiliary terminals:
 - 2x micro terminals DBZ1190-AA and
 - 2x connection terminals DBZ1190-AB
- The internal alarm indicator is centered in the detector, which makes alignment of the point detector superfluous.

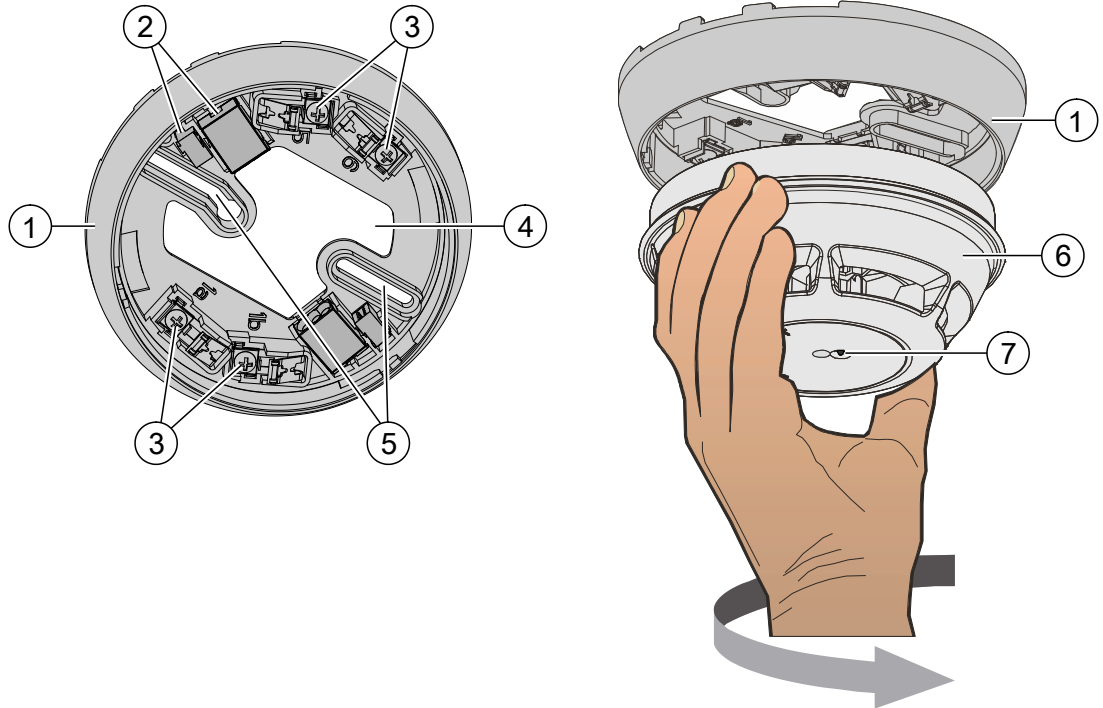

| | | | |
|---|--|---|--------------------------|
| 1 | Detector base | 5 | Mounting slits |
| 2 | Auxiliary terminals DBZ1190-AA, DBZ1190-AB | 6 | Point detector |
| 3 | Screw terminals for detector line and external alarm indicator | 7 | Internal alarm indicator |
| 4 | Opening for cable entry | | |

Disposal



The device is considered an electronic device for disposal in accordance with European Directive and may not be disposed of as domestic waste.

- Use only designated channels for disposing the devices.
- Comply with all local and currently applicable laws and regulations.
- Dispose of empty batteries at designated collection points.

Technical data

| | OH720 | OP720 | HI720 / HI722 |
|--|---|---|----------------------|
| Operating voltage | DC 12...33 V | DC 12...33 V | DC 12...33 V |
| Operating current (quiescent) | ~230 µA | ~220 µA | ~200 µA |
| Max. number of external alarm indicators that can be connected | 2 | 2 | 2 |
| Operating temperature | -10...+55 °C | -10...+55 °C | -10...+55 °C |
| Storage temperature | -30...+70 °C | -30...+70 °C | -30...+70 °C |
| Air humidity (short-term moisture condensation permitted) | ≤95 % rel. | ≤95 % rel. | ≤95 % rel. |
| Communication protocol | C-NET | C-NET | C-NET |
| Color | ~RAL 9010 pure white ~RAL 9005 jet black | ~RAL 9010 pure white ~RAL 9005 jet black | ~RAL 9010 pure white |
| Weight | 0.144 kg | 0.138 kg | 0.130 kg |
| Protection category (IEC 60529) | IP40 | IP40 | IP40 |
| Protection category (IEC 60529) with detector base seal RS720 | IP42 | IP42 | IP42 |
| Standards | EN 54-7, EN 54-17, EN 54-29 | EN 54-7, EN 54-17 | EN 54-5, EN 54-17 |
| Approvals | | | |
| • VdS | G209064 | G209068 | G209065 / G209146 |
| • LPCB | 531w/01 | 531e/01 | 531f/01 / 531f/02 |
| • FM | 3038424 | 3038424 | 3037921 |
| • DNV GL (marine) | MEDB00003UK | MEDB00003UK | MEDB00003UR |
| Permissible wind speed | Max. 5 m/s | Max. 5 m/s | - |
| C-NET system compatibility | FS720, FC360 | FS720, FC360 | FS720, FC360 |

Dimensional drawings

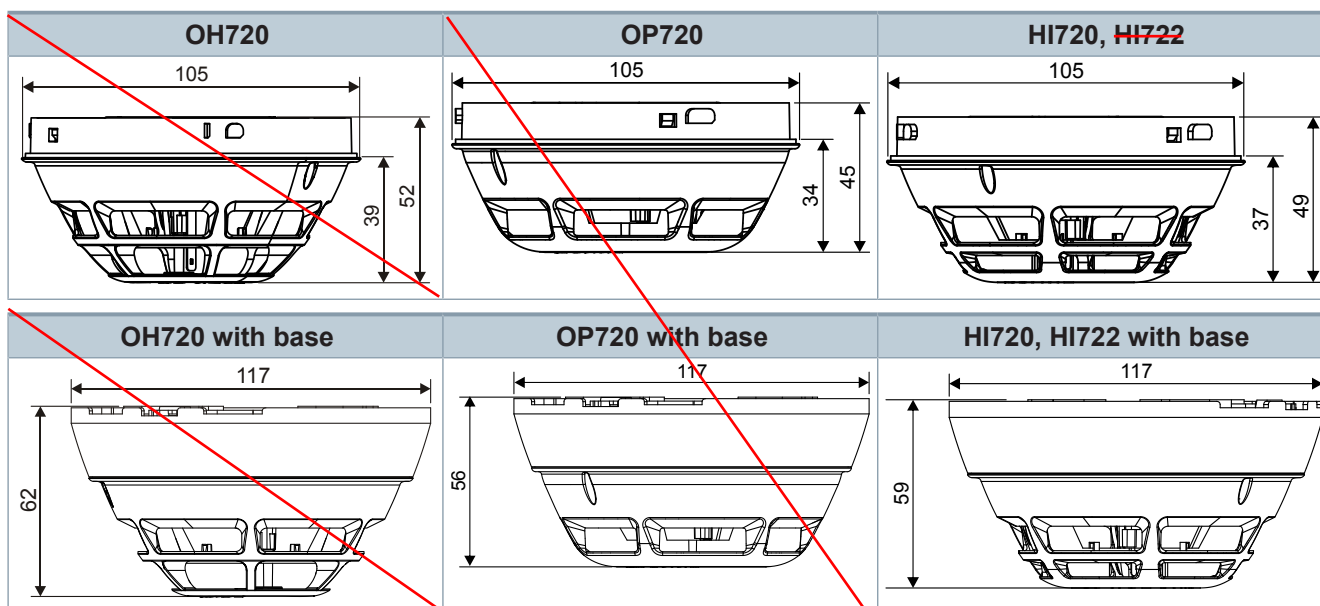

Product documentation

| Dokument-ID | Titel |
|-------------|---|
| 008115 | Installation Detector heating FDBH291 |
| A6V10200373 | Installation Detector base with loop contact DB721, DB722, detector base DB720, sounder base DBS720, detector base seal RS720, detector locking device LP720, base attachment BA720 |
| A6V10203095 | Data sheet Sounder base, Alarm sounders DBS720, FDS221-R, FDS221-W |
| A6V10203222 | Data Sheet Testequipment and accessories FDUL221, DX791, RE6, RE7T, RE8ST, RE8STCO, FDUM29x, LE3, StabexHF |
| A6V10212047 | Technical Manual Automatic fire detectors OH720, OP720, HI720, HI722 |
| A6V10229261 | List of compatibility (for 'Cerberus™ PRO' product line) |
| A6V10393192 | List of compatibility (for 'Cerberus™ FIT' product line) |
| A6V10406006 | Installation Base attachment wet BA721, Detector designation plate DBZ1193A, Protective cage DBZ1194, EMC-protective cage FDBZ294 |

Issued by
Siemens Switzerland Ltd
Smart Infrastructure
Global Headquarters
Theilerstrasse 1a
CH-6300 Zug
+41 58 724 2424
www.siemens.com/buildingtechnologies

© Siemens Switzerland Ltd, 2008
Technical specifications and availability subject to change without notice.

Certificate of Product Approval

Certificate Number: 531f-(cl-1)

Issue: 07

Siemens Switzerland Ltd

Theilerstrasse 1a
CH-6300 Zug
Switzerland



is certified by BRE Global Ltd. and is authorised to use the LPCB mark in association with the product(s) listed in this certificate and appendix having complied with the requirement(s) of the standards as detailed below:

Products

Heat Detectors

HI720

~~HI722~~

~~HI360~~

(refer to Appendix for details)

Standards

EN 54-5:2017 + A1:2018

EN 54-17:2005

This Certificate is maintained and held in force through regular surveillance activities and subject to the corresponding ISO 9001 Certificate being maintained.

Signed for BRE Global Ltd

P Halligan

Verifier

22 February 2022

Date of Issue

4 December 2009

Date of First Issue



This certificate and appendix remains the property of BRE Global Ltd. and is issued subject to terms and conditions (for details visit www.redbooklive.com/terms).

To check the validity of this certificate and appendix please visit www.redbooklive.com/check, scan the QR tag or contact us.

BRE Global Ltd, Watford, WD25 9XX

T: +44 (0)333 321 8811 E: enquiries@breglobal.com

LPCB is a Registered Trademark of the Building Research Establishment Ltd.



Appendix to Certificate No: 531f-(cl-1)

Issue: 07

Siemens Switzerland Ltd

| Certified Product | Description | LPCB Ref.No. |
|-------------------|--|--------------|
| HI720 | Analogue Addressable Class A2S and A2R Heat Detector with Short Circuit Isolator (DB720, DB721, DB722 bases, BA720, BA721 base adaptor) Notes: 1. Meets the requirements of EN 54-5 at classes A2S and A2R | 531f/01 |
| HI722 | Analogue Addressable Class A2S Heat Detector with Short Circuit Isolator (DB720, DB721, DB722 bases, BA720, BA721 base adaptor) Notes: 1. Meets the requirements of EN 54-5 at class A2S | 531f/02 |
| HI360 | Analogue Addressable Class A2S and A2R Heat Detector with Short Circuit Isolator (DB721, DB722, DB720 bases, BA720, BA721 base adaptor) Note: 1. Meets the requirements of EN 54-5 at classes A2S and A2R | 531f/05 |

Bases

DB720 Detector base
DB721 Detector base with loop contact
DB722 Detector base
BA720 base adaptor
BA721 base adaptor

This Certificate is maintained and held in force through regular surveillance activities and subject to the corresponding ISO 9001 Certificate being maintained.



Signed for BRE Global Ltd

P Halligan

Verifier

22 February 2022

Date of Issue

4 December 2009

Date of First Issue



This certificate and appendix remains the property of BRE Global Ltd. and is issued subject to terms and conditions (for details visit www.redbooklive.com/terms).

To check the validity of this certificate and appendix please visit www.redbooklive.com/check, scan the QR tag or contact us.

BRE Global Ltd, Watford, WD25 9XX
T: +44 (0)333 321 8811 E: enquiries@breglobal.com

LPCB is a Registered Trademark of the Building Research Establishment Ltd.





To Whom It May Concern

| | |
|----------------|--|
| Name | Calvin Yeung |
| Division | Smart Infrastructure |
| Department | Sales |
| Telephone | (852) 6312 5070 |
| Fax | (852) 2407 4457 |
| Mobile | (852) 6312 5070 |
| E-mail | calvin.yeung@siemens.com |
| Internet | www.siemens.com.hk |
| Your letter of | |
| Our reference | MF/COO/CP |
| Date | 10 Dec 2025 |

Dear Sir / Madam,

Re: Country of Origin for “Siemens” Cerberus Pro Automatic Fire Alarm System

| Model No. | Description | Country of Origin |
|-----------------------------|---------------------------------------|--------------------------|
| FC726 | Addressable Fire Alarm Panel | Switzerland |
| FC724 | Addressable Fire Alarm Panel | Switzerland |
| FC723 | Addressable Fire Alarm Panel | Switzerland |
| FC722 | Addressable Fire Alarm Panel | Switzerland |
| FC721 | Addressable Fire Alarm Panel | Switzerland |
| FT724 | Repeater Panel | Switzerland |
| OP720 | Smoke Detector | China |
| HI720 | Heat Detector | China |
| HI722 | Heat Detector | China |
| OH720 | Multi-Sensor Smoke Detector | China |
| OOHC740 / OOH740 | Multi-Sensor Smoke Detector | Switzerland |
| OOH740-A9-EX | Explosion Proof Smoke / Heat Detector | Switzerland |
| FDB201 | Detector Base | Switzerland |
| DB721 / DB722 | Detector Base | China |
| FDM221 / FDM231-RP | Manual Call Point | China |
| FDM225-RP | Manual Call Point | Great Britain |
| FDM225-RG | Manual Call Point | Great Britain |
| FDMH295-R | Back Box for MCP | China |
| FDM226-RP | Manual Call Point Weatherproof | Great Britain |
| FDM226-RG | Manual Call Point Weatherproof | Great Britain |
| FDCIO221 | Input/ Output Module | China |
| FDCI221 | Input Module | China |
| FDCI222 | Input Module | China |
| FDCIO222 | Input/ Output Module | China |
| FDCIO223 | Input Module for Special Detector(s) | China |
| FDCH221 | Housing for Module | China |
| FC121-ZA | Conventional Fire Control Panel | China |
| DCA1192A | Line Coupler | Switzerland |
| DCB1192A | Terminal Plate | China |
| FDBH291 | Anti-Condensation Heater | China |
| FDB295 | Wet Base | China |
| DCA1191 | Housing | China |
| STAHL / 9001-00-280-100-101 | Safety Barrier | Slovakia |
| DBS720 / FDSB226 | Sounder Base | China |
| FT2011-A1 / FT2010-A1 | Floor Repeater | Switzerland |

| | | |
|--------------------|---------------------------------------|---------------|
| FDL242 | Linear Smoke Detector / Beam Detector | Great Britain |
| FDLR242 | Reflective Prism | Great Britain |
| FDLRLA242 | Reflector for long / short distance | Great Britain |
| FDF242 / FDF242-EX | Flame Detector | Norway |
| FDA241 | Air Sampling Smoke Detector | Switzerland |
| FDA261 | Air Sampling Smoke Detector | Switzerland |
| FDCC221S | Communication Interface for FDA241 | Switzerland |

Should you have any query, please do not hesitate to contact the undersigned at (852) 6312 5070.

Thank you for your kind attention.

Yours faithfully,
Siemens Limited

Calvin Yeung

Digitally signed by
Yeung Wing Fai 
DN: cn=Yeung Wing
Fai, o=DF

Assistant Sales Manager



To Whom It May Concern

| | |
|----------------|--|
| Name | Nelson Chow |
| Division | Smart Infrastructure - Buildings |
| Department | Sales |
| Telephone | (852) 9721 6830 |
| Fax | (852) 2407 4457 |
| Mobile | (852) 9721 6830 |
| E-mail | nelson.chow@siemens.com |
| Internet | www.siemens.com.hk |
| Your letter of | |
| Our reference | MF0933/07/NC |
| Date | 15 Dec 2025 |

Dear Sir / Madam,

Re: Compatible letter for “Siemens” Automatic Fire Alarm System

We write to confirm that “Siemens” FC726 / FC724 / FC723 / FC722 / FC721 Fire Alarm Panel is compatible with OP720, Smoke Detector, OOH740 / OOHC740 Multi-sensor smoke detector, HI720 / HI722 Heat Detector, DBS720 / FDSB226 Sounder Base, FDM231/ FDM225-RP / FDM226-RP Manual Call Point, FDCI221, FDCI222 Input Module, FDCIO221, FDCIO222 Input/ Output Module, FDCIO223 Input Module for Ex-application, OOH740-A9-Ex explosion proof smoke/ heat detector, STAHL 9001/00-280-100-101 safety barrier, FC121-ZA conventional Panel and FT2011-A1 / FT2010-A1 & FT724 repeater.

Should you have any query, please do not hesitate to contact the undersigned at (852) 9721 6830.

Thank you for your kind attention.

Yours faithfully,
Siemens Limited

 Digitally signed by
Chow Siu Wah
Location: Hong
Kong (RC-HK SI
B) by Nelson
Chow

Nelson Chow
Head of V&E Customers Sales
Smart Infrastructure - Buildings



SIEMENS 'SINTESO / CERBERUS PRO' Addressable AFA System

FC2020/ FC2020-AA/ FC2020-AE/ FC2020-AZ/ FC2020-EZ; FC2030/ FC2030-AA;
FC2040/FC2040-AA/FC2040-AG; FC2060 / FC2060-AA; FC2080; FC721/FC721-ZZ/ FC721-ZA;
FC722 / FC722-ZZ/ FC722-ZA; FC723/ FC723-ZA; FC724/ FC724-ZZ/ FC724-ZA; FC726/
FC726-ZA FS 20 Series Main Fire Alarm Panel
FT2040 / FT724 / FT2011-A1/ FT2010-A1 Repeater Panel
FT2001-A1 Mimic Display Driver
FDOOTC241/ FDOOT241-A/ FDOOT221 / OH720 / OOH740 / OOHC740 Multi-sensor
Detector
OP720 / FDO221/ FDO241 Smoke Detector/ FDT221/ FDT241 / HI720 / HI722 Heat
Detector
FDB222/ DB721/ DB722 Detector Base/ FDSB291 / DBS720 / FDSB226 Sounder Base
FDM231 / FDM221 / FDM225-RG & FDM225-RP (Indoor)/ FDM226-RG & FDM226-RP
(Outdoor) Manual Call Point & FDMH295-R Back Box for MCP
FDCIO221/ FDCI221 / FDCI222/ FDCIO222/ FDCIO223 Input & Output Module

MAJOR JOB REFERENCE (Hong Kong)

| Project (Hong Kong) | Client | Date Commenced |
|--|-----------------------------------|----------------|
| Tamar Government Headquarter | Architectural Services Department | 02/2008 |
| Tuen Mun Riding School | Hong Kong Jockey Club | 03/2008 |
| Toy Story, Hong Kong Disneyland | Hong Kong Government/ Walt Disney | 05/2008 |
| Fortune Terrace | Hongfaith Engineering Ltd | 06/2008 |
| River Beas Club House | Hong Kong Jockey Club | 10/2008 |
| Shatin Racecourse | Hong Kong Jockey Club | 10/2008 |
| HAPPY VALLEY RACECOURSE (HVRC) – INFIELD (including Large Video Screen and Indicators) | Hong Kong Jockey Club | 10/ 2008 |
| Lai See Industrial Building | Fook Cheong Engineering (HK) Ltd. | 03/2009 |
| Temple at Tuen Mun | Kin Ying Contracting Company | 03/2009 |
| Aberdeen Ball Club | Aberdeen Ball Club | 03/2009 |

SIEMENS

| | | |
|---|-------------------------------------|----------|
| YoHo Midtown | Sun Hung Kai Properties Ltd. | 03/2009 |
| No.32 Chung Hom Kok | Hongfaith Engineering Ltd.' | 04/2009 |
| Siu Sai Wan Complex | Architectural Services Department | 04/2009 |
| Church at No 18 Cornwall Street | Hongfaith Engineering Ltd | 06/2009 |
| East Ocean Centre | Hongfaith Engineering Ltd | 06/2009 |
| LaSalle College | LaSalle College | 07/2009 |
| 235-245 Queen's Road East (Open Kitchen) | Nan Fung Development | 07/2009 |
| Mytics, Hong Kong Disneyland | Hong Kong Government/ Walt Disney | 08/2009 |
| St. Paul Hospital | St. Paul Hospital | 09/2009 |
| Hong Kong Exhibition and Convention Centre | Hong Kong Trade Development Council | 10/2009 |
| 863-865 King's Road | Kerry Properties Ltd | 10/ 2009 |
| Proposed Hotel Development 119-120 Connaught Road, Central | Kin Ying Engineering Ltd | 10/ 2009 |
| No. 6 Siu Fai Terrace | Hongfaith Engineering Ltd | 10/ 2009 |
| Kee Wah Factory | Kee Wah Group | 12/2009 |
| Adventist Hospital, Hong Kong | Adventist Hospital | 01/2010 |
| 3-5 Star Street | Swire Properties | 02/2010 |
| Tong Yan Sun Tsuen | New World Group | 02/2010 |
| Primary School at Shek Kip Mei Phase 4 | Architectural Services Department | 04/2010 |
| Sports Centre in Area 28A Fanling Sheung Shui (SST301) | Architectural Services Department | 04/2010 |
| KL 11146 Hoi Fai Road, Kowloon | Sun Hung Kai Properties Ltd. | 05/2010 |
| 77-85 Bedford Road | Ka Wah International | 05/2010 |
| No 24-32 Ming Yuen Western Road | Kowloon Development Co., Ltd. | 06/2010 |
| 1-3 Victory Avenue. Ho Man Tin | Ka Wah International | 06/2010 |
| Substation 207, Infrastructure Expansion, | Hong Kong Government/ Walt Disney | 06/2010 |

SIEMENS

Parkwide, Hong Kong Disneyland

| | | |
|--|---|---------|
| St. Francis Canossian School | St. Francis' Canossian School | 06/2010 |
| Park at Tin Shui Wai | Architectural Services Department | 06/2010 |
| Tsui Wah Building at No. 51, Lai Yip Street, Kwun Tong | Tsui Wah Restaurant | 06/2010 |
| City Hall, Central | Architectural Services Department | 06/2010 |
| Li Po Chun United world College | Li Po Chun United World College | 06/2010 |
| 102F T1 International Trade Centre | Sun Hung Kai Properties Ltd. | 07/2010 |
| Li Shu Fan Phase I, The University of Hong Kong | The University of Hong Kong | 08/2010 |
| Latitude, San Po Kong | Sun Hung Kai Properties Ltd. | 08/2010 |
| Kennedy Town Swimming Pool Phase I | MTRC / Architectural Services Department | 09/2010 |
| Infrastructure Expansion, Building 638, Substation 208, Hong Kong Disneyland | Hong Kong Government / Walt Disney | 09/2010 |
| Club Siena, Discovery Bay | Hong Kong Resort Company Ltd. | 09/2010 |
| Proposed Hotel Development at 2 & 4 Hau Wo Street, Kennedy Town | Kin Ying Contracting Ltd. | 10/2010 |
| Proposed Industrial Building at Lop Yip Street & Yip Cheong Street, Fanling | Kin Ying Contracting Ltd. | 10/2010 |
| Warehouse, Hong Kong Disneyland | Hong Kong Government/ Walt Disney | 10/2010 |
| Nurse Quarters, St Teresa Hospital 20& 22 Lonmond Road | St. Teresa Hospital | 10/2010 |
| West Island Line- Reprovision of David Trench Rehabilitation Centre | MTRC/ Architectural Services Department | 10/2010 |
| Grizzly Gulch, Hong Kong Disneyland | Hong Kong Government / Walt Disney | 11/2010 |
| HKCCCU Logos Academy Extension, TKO | HKCCCU Logos Academy | 11/2010 |
| VTC, 145 Pokfulam | Vocational Training Centre | 11/2010 |

SIEMENS

| | | |
|--|-----------------------------------|----------|
| 1111 Wuhu Street, Hunghom / Wuhu Residence (Open Kitchen) | Chong's Properties | 11/2010 |
| Centennial Campus Phase 1, The University of Hong Kong | The University of Hong Kong | 01/2011 |
| Mongkok Dental Clinic | Architectural Services Department | 01/2011 |
| Custom & Excise Department Married Staff Quarters at 9-11 Tsing Chau Street | Architectural Services Department | 01/2011 |
| International School at Discovery Bay | Shun Hing Contracting Ltd | 04/2011 |
| 18-36 Shing On Street (Open Kitchen) | Emperor Properties | 04/2011 |
| Ma Wan Rural Committee Office | Ma Wan Rural Committee | 05/2011 |
| PLK Centenary Li Shiu Chung Memorial College, Tai Hing Estate Tuen Mun | Architectural Services Department | 05/2011 |
| PLK Tang Yuk Tien College, Wu King Estate, Tuen Mun | Architectural Services Department | 05/2011 |
| Food Inspection Centre, Man Kam Road | Architectural Services Department | 05/ 2011 |
| Sunshine City, Ma On Shan | Henderson Real Estate Agency | 06/2011 |
| King Ying Street, Kwun Tong | Henderson Real Estate Agency | 08/2011 |
| Nin Jiom Medicine Manufacturing Plant | Nin Jiom Medicine | 08/2011 |
| Pharmacy Workshop 46 Wang Lee Street, Yuen Long | Private Pharmacy Company | 09/2011 |
| 1800 Student Hostel, The University of Hong Kong | The University of Hong Kong | 10/ 2011 |
| Kowloon City SPSI & 2 | Drainage Services Department | 10/2011 |
| Yuen Fat Godown | Yuen Fat Fodown | 10/2011 |
| Sunshine City Plaza, Ma On Shan | Henderson Real Estate Agency Ltd. | 10/2011 |
| No. 21 Tai Tam Road | Liaison Office of the Central | 11/2011 |

| | | |
|---|-----------------------------------|---------|
| | Peoples Government in H.K. SAR | |
| Residential Development Fuk Wing Street | Chinachem Group | 12/2011 |
| CIC-Zero Carbon Building | Hong Kong SAR Government | 12/2011 |
| Central Reclamation Phase II | Architectural Services Department | 01/2012 |
| Happy Valley Racecourse – Public Stand | The Hong Kong Jockey Club | 01/2012 |
| Castle Peak Hospital | Architectural Services Department | 02/2012 |
| Ma Wan Hostel | Sun Hung Kai Properties Ltd | 02/2012 |
| TKOTL 76 Area 66B | Sun Hung Kai Properties Ltd | 04/2012 |
| 771B Kennedy Town Station, West Island Line | MTRC | 05/2012 |
| Central Wanchai Bypass at Wanchai East | Highway Department | 06/2012 |
| Tsing Lung Tao | Sun Hung Kai Properties Ltd | 06/2012 |
| Queen Mary Hospital Nurse Quarters | EMSD | 06/2012 |
| Prince of Wales Hospital Main Block | EMSD | 06/2012 |
| The Peninsula Hotel | The Peninsula Hong Kong | 01/2013 |
| The construction of Sports Centre, Community Hall and District Library in Area 148 Shatin | Architectural Services Department | 02/2013 |
| 11 Jones Street & 11 Warren Street, Tai Hang | Wing Tai Asia | 02/2013 |
| New Factory of Maxim's on No 5 Dai Shun Factory Tai Po | Maxim's | 02/2013 |
| Engineer's Site Accommodation Po Kong Village Road | Architectural Services Department | 02/2013 |
| University Street (Phase 3) | The University of Hong Kong | 02/2013 |
| Regal Riverside Hotel | Regal Hotel | 03/2013 |
| Tsing Fung Street Hotel | King Ying Contracting Ltd | 03/2013 |



| | | |
|--|-----------------------------------|---------|
| Chow Yei Ching Building | The University of Hong Kong | 04/2013 |
| Central Police Station Conservation & Revitalization | Hong Kong Jockey Club | 05/2013 |
| Hotel, Queen's Road Central | Sino Properties | 07/2013 |
| Hotel, 6 Krusford Terrace | Henderson Land Development Ltd | 08/2013 |
| Bright Future Pharmacy Plant, Yuen Long | Bright Future Pharmacy | 09/2013 |
| 75-81 Sa Po Road | Chinachem Properties | 10/2013 |
| 110A-110B Argyle Street | Kerry Properties | 11/2013 |
| Communication & Technologies Centre, Shatin | Hong Kong Jockey Club | 11/2013 |
| Butterfly Hotel, TST | Butterfly Hotel Group | 11/2013 |
| Un Chau Street | Chinachem Properties | 11/2013 |
| Cheung Sha Residential Bldg | Sino Properties | 11/2013 |
| Tin Shui Wai Temp Site Office | Sky Eng | 11/2013 |
| 3-5 Ede Road | Chinachem Properties | 12/2013 |
| TKOTL 76 Area 66C1 | Sun Hung Kai Properties | 12/2013 |
| Shatin 14B Sport Center | Architectural Services Department | 12/2013 |
| TKOL TL39 and Extension | Hongfaith Engineering | 01/2014 |
| 18-32 Junction Road | Shun Cheong Electrical | 01/2014 |
| Block B, St. Paul's Hospital | St. Paul's Hospital | 01/2014 |
| Pauline Chan Building | The University of Hong Kong | 01/2014 |
| Dept. of Justice Relocation | Architectural Services Department | 02/2014 |
| Deep Water Road | Sun Hung Kai Properties | 02/2014 |
| New Koala Attraction, Ocean Park | Ocean Park Corporation | 03/2014 |
| New Ambulance Depot, Sheung Shui | Architectural Services Department | 02/2014 |
| 6 Krusford Terrace Hotel | Henderson Land Development | 04/2014 |

SIEMENS

| | | |
|--|--|---------|
| Area 66C1, TKO | Sun Hung Kai Properties Ltd | 04/2014 |
| Deep Water Bay Road | Sun Hung Kai Properties Ltd | 04/2014 |
| Postgraduate Residence/ Hostel | The University of Hong Kong | 05/2014 |
| 39-43 Nga Tsin Wai Road | Suen Tat Metal Machine Factory | 05/2014 |
| TDS, Disneyland | Hong Kong Government / Walt Disney | 06/2014 |
| MTRC1126, Wan Chai Sport Complex | MTRC/ Architectural Services Department | 06/2014 |
| Langham Hotel, TST | Langham Hotel | 07/2014 |
| 21-27A Chatham Road, TST | Joinwell Technical | 08/2014 |
| Lot 52, Shatin | Architectural Services Department | 10/2014 |
| Castle Peak Hospital | Architectural Services Department | 10/2014 |
| Kwong Wah Hospital | Architectural Services Department | 10/2014 |
| Patrick Mansion Building (North Wing) | The University of Hong Kong | 10/2014 |
| 74 Queen's Road Central Hotel | Sino Group | 11/2014 |
| Chung On Street, Tsuen Wan | Li's Fire | 11/2014 |
| 91-103 Parkes Street | Chuang's Consortium Int. | 11/2014 |
| 42 Wang Lee Street | Productive | 11/2014 |
| Maxim's Factory at Tai Po | Maxim's | 12/2014 |
| Belvedere Garden Shopping Centre | Belvedere Garden | 12/2014 |
| Proposed Hotel at 89-100 Tung Lo Wan Rd | Better Chance International Ltd. | 12/2014 |
| Lei Garden Food Factory | Lei Garden Restaurant Group | 12/2014 |
| Harbour Road Sports Centre | Leisure & Cultural Services Department | 12/2014 |
| TKO Area 66C1 Residential Development | Sun Hung Kai Properties Ltd/ MTRC | 01/2015 |
| Heng Seng School of Commerce | Heng Seng School of Commerce | 03/2015 |
| Conversion of Senior Staff Quarter at | Architectural Services Department | 03/2015 |

SIEMENS

Mary Hospital

| | | |
|--|--|---------|
| DD331 Cheung Sha | Swire Properties | 04/2015 |
| Langham Hotel, TST | Langham Hotel | 04/2015 |
| Iron Man Experience, Hong Kong Disneyland | Hong Kong Government/ Walt Disney | 06/2015 |
| Heng Sang Bank at Mongkok | Heng Sang Bank | 06/2015 |
| Gleneagles HK Hospital | GHK/ New World Development | 05/2015 |
| Arts Pavilion, West Kowloon Cultural District | West Kowloon Cultural District | 06/2015 |
| MTRC Contract 1123, EXH & Wan Chai Sport Complex | MTRC / Architectural Services Department | 06/2015 |
| M+ Museum Mock Up, West Kowloon Cultural District | West Kowloon Cultural District | 07/2015 |
| Heng Seng Bank, Arygle Street, Mongkok | Heng Seng Bank | 08/2015 |
| Kennedy Town Swimming Pool Phase 2 | MTRC / Architectural Services Department | 09/2015 |
| 18 Pik Sha Street | Chinachem Group | 09/2015 |
| TW5 City Side Residential Development | Chinachem Group/ MTRC | 12/2015 |
| TW5 Bay Side Residential Development Phase 1 | Cheung Kong Holdings Ltd/ MTRC | 04/2016 |
| Tak Yip Street, Yuen Long | Sun Hung Kai Properties Ltd | 04/2016 |
| Shek Lei Shopping Centre | Housing Authority / The Link | 04/2016 |
| Siu Lik Yuen Hotel | Sun Hung Kai Properties Ltd | 05/2016 |
| TW5 Bay Side Residential Development Phase 2 | Cheung Kong Holdings Ltd/ MTRC | 06/2016 |
| 35 Baker Road, Peak | Henderson Land | 07/2016 |
| Town Lot No.70 Area 86, Site D LOHAS Park, Package 4 | Sun Hung Kai Properties Ltd/ MTRC | 09/2016 |
| 18 & 20 Caine Road | Sun Hung Kai Properties Ltd | 10/2016 |
| Caritas Social Centre at | The Catholic Diocese of Hong Kong | 10/2016 |

9 Sheng Mun Road, Tsuen Wan

| | | |
|---|--|---------|
| Hong Kong-Zhuhai-Macao Bridge Hong Kong Link Road Section Between HKSAR Boundary & Scenic Hill | Hong Kong Government | 10/2016 |
| The Fleming Hotel Renovation | The Fleming Hotel | 11/2016 |
| Proposed Hotel at 33-49, Des Voeux Road | Nan Fung Group | 11/2016 |
| Global Switch Data Centre at Tseung Kwan O Industrial Estate Phase 1 | Global Switch Hong Kong Limited | 11/2016 |
| Wong's Industrial Centre at 180 Wai Yip Street, Kwun Tong | Wong's International Holdings Ltd. | 12/2016 |
| House 18, Bisney Crest, 55-57 Bisney Road | Chinachem Group | 12/2016 |
| Island Residence 163 Shaukeiwan Road | Wheelock Properties (Hong Kong) Ltd. | 12/2016 |
| Haking Wong Building | The University of Hong Kong | 12/2016 |
| Proposed Residential Building 565 Kau To Shan | Eco-Green Group Limited | 01/2017 |
| Proposed Residential Building 163 Kau To Shan | Eco-Green Group Limited | 02/2017 |
| Kwai Chung Hospital Block LM | EMSD | 04/2017 |
| MTRC1126 Wan Chai Swimming Pool | MTRC / Architectural Services Department | 04/2017 |
| HK-Zhuhai-Macau Bridge Hong Kong Link Road Section Between Scenic Hill and Hong Kong Boundary Crossing Facilities | Hong Kong Government | 05/2017 |
| Xiqu Centre | West Kowloon Cultural District | 05/2017 |
| 17-19 Yik Yam St. Happy Valley | Emperor International Holdings Ltd | 06/2017 |
| 310 Prince Edward Road West/ Gallant Villa | United Properties Ltd. | 06/2017 |
| HK-Zhuhai-Macau Bridge Hong Kong Link Road / PCB | Highways Department | 06/2017 |

SIEMENS

| | | |
|--|--|---------|
| Imperial Cullinan Upgrade | Sun Hung Kai Properties Ltd. | 07/2017 |
| 8-10 Wong Chuk Hang Road | Swire Properties | 07/2017 |
| Lin Fa Kung Street (Site C) | Better Chance International | 07/2017 |
| Lin Fa Kung Street (Site D) | Better Chance International | 07/2017 |
| Hong Chi Phase 2 | Hong Chi Association | 09/2017 |
| The West Wing of Central Government Office | Architectural Services Department | 10/2017 |
| Butterfly Hotel at Austin Road | Butterfly Hotel | 11/2017 |
| Coach Parking for Ocean Park | Ocean Park Corporate | 11/2017 |
| 68-86 Wang Fung Street | Far East Properties | 12/2017 |
| Siu Lik Yuen Hotel | Sun Hung Kai Properties | 12/2017 |
| West Kowloon Government Office at Yau Ma Tei | Architectural Services Department | 01/2018 |
| TKOTL70 Area 86, Site N, LOHAS Park, Package 6 | Nan Fung Group/ MTRC | 01/2018 |
| FSSTL225, J/O Luen Hing Street, Fanling | Henderson Land | 01/2018 |
| Hong Kong Sanatorium Hospital (Happy Valley) | HK Sanatorium Hospital | 03/2018 |
| Global Switch Data Centre at Tseung Kwan O Industrial Estate Phase 2 | Global Switch Hong Kong Ltd. | 04/2018 |
| TMTL 500 Kwun Chiu Road, Tuen Mun | Evergrande Real Estate | 06/2018 |
| OT Block Expansion, Tuen Mun Hospital | Hong Kong Hospital Authority | 06/2018 |
| Eastern Medical Centre at 5AKN | Hong Kong Sanatorium Hospital | 07/2018 |
| Kings Wing Plaza | Billion Development and Project Management Ltd | 07/2018 |
| Primary School at Anderson Road, Kwun Tong | Architectural Services Department | 09/2018 |
| 6-22 Chung Ching Street | Henderson Land Group | 10/2018 |
| Stubb Road | Sun Hung Kai Properties Ltd | 12/2018 |

| | | |
|---|---|---------|
| HK Airport Contract 3712 – New Project Site Office | The Airport Authority Hong Kong | 12/2018 |
| KGO Pumpcell at West Kowloon Cultural Centre | West Kowloon Cultural District Authority | 12/2018 |
| EP, Panda Café & AAA, Ocean Park | Ocean Park Corporation | 12/2018 |
| Hing Hon Road | Kerry Properties Limited | 01/2019 |
| A New Club House at Shan Kwong Road | Hong Kong Jockey Club | 01/2019 |
| Ki Lung Street | Henderson Land | 01/2019 |
| Lai King Workshop | Architectural Services Department | 01/2019 |
| Chun Yip Street Market | Architectural Services Department | 01/2019 |
| 1-11 Kwai Hei Street | Henderson Land | 02/2019 |
| 411 Catham Road North | Henderson Land | 02/2019 |
| A Boy School in Area 28 Tuen Mun | Architectural Services Department | 03/2019 |
| No. 106 Yip Wong Road Tuen Mun Lot. No. 514 | Henderson Land Development Company Limited | 03/2019 |
| The Arch, Kowloon Station | Sun Hung Kai Properties Ltd | 03/2019 |
| Residential Dev. TKOTL70 Site | Cheung Kong (Holdings) Limited/ MTRC | 03/2019 |
| 180-184 Shau Kei Wan Road | EASE Day Limited | 04/2019 |
| Vehicle Exam Centre Tsing Yi | Transport Department | 04/2019 |
| Tai Wai Station STTL No.52 | New World Development Co Ltd/ MTRC | 04/2019 |
| STTL601 Yiu Sha Rd, Ma On Shan | Country Garden (Hong Kong) Ltd | 05/2019 |
| Tuen Mun Hospital New OT Blk Extension | Hong Kong Hospital Authority | 06/2019 |
| Medical Complex Extension | The University of Hong Kong | 06/2019 |
| Shek Wu Hui Sewage Treatment Work | Drainage Services Department, HKSAR | 07/2019 |
| 68-70 Electric Road | Success Seeker Limited | 07/2019 |

SIEMENS

| | | |
|--|--|---------|
| Ocean Park Waterfront | Ocean Park Corporation | 07/2019 |
| Eastern Medical Centre at 3AKN | Hong Kong Sanatorium Hospital | 07/2019 |
| Castle, Hong Kong Disneyland | Hong Kong International Theme Parks Ltd | 08/2019 |
| Grandstand South & Training Pool, South China Athletic Association | South China Athletic Association | 08/2019 |
| Fu Shan Public Mortuary | Architectural Services Department | 08/2019 |
| TMTL500, Kwun Chiu Road, Tuen Mun | China Evergrande Group | 08/2019 |
| Global Switch HK1 Building 4 & 5 | Global Switch Hong Kong Limited | 09/2019 |
| Win Plaza | Henderson Land Development Company Limited | 09/2019 |
| CLP Black Point Power Station D1 | CLP Power Hong Kong Ltd. | 09/2019 |
| HKSTP Innocell Residential Institution | Hong Kong Science Park | 11/2019 |
| Inland Revenue Tower | Architectural Services Department | 12/2019 |
| 33 Tin Shui Wai, Yuen Long | Sun Hung Kai Properties Ltd | 12/2019 |
| YOHO Hub at Yuen Long Station | Sun Hung Kai Properties Ltd/ MTRC | 12/2019 |
| Kwai Chung Hospital Phase 2 | Hospital Authority | 12/2019 |
| Area 54, Siu Hong, Tuen Mun | Sun Hung Kai Properties Ltd | 02/2020 |
| Arendelle, Hong Kong Disneyland | HK International Theme Parks Ltd | 02/2020 |
| Regal TST Hotel | Regal Hotel Group | 02/2020 |
| APIL136, Ap Lei Chau | Unicorn Bay (HK) Investment Ltd | 02/2020 |
| Christian Zheng Sheng College | Christian Zheng Sheng College | 02/2020 |
| IE2.0, Advanced Manufacturing Centre, TKO | Hong Kong Science Park | 03/2020 |
| Tai Po Town Lot 223 & 229 | HKR International Limited | 03/2020 |
| Town Lot 33, Area 112, Tin Shui Wai | Sun Hung Kai Properties Ltd. | 03/2020 |

SIEMENS

| | | |
|--|---|---------|
| Butterfly on Prat Boutique Hotel at Tsim Sha Tsui | Butterfly on Prat Boutique Hotel | 05/2020 |
| HKAA 3722 Third Runway Site Office | Airport Authority | 06/2020 |
| Queen Mary Hospital | Architectural Services Department | 06/2020 |
| Penny Bay Phase 2 | Architectural Services Department | 07/2020 |
| A 30 Classroom primary school at Tokin Street, Cheung Sha Wan | Architectural Services Department | 08/2020 |
| Whisker Harbour, Ocean Park | Ocean Park Corporation | 10/2020 |
| Penny's Bay Phase 3A | Architectural Services Department | 10/2020 |
| Penny's Bay Phase 3B | Architectural Services Department | 10/2020 |
| Penny's Bay Phase 4 | Civil Engineering and Development Department | 11/2020 |
| Adventure Land, Ocean Park | Ocean Park Corporation | 11/2020 |
| VAC System for Inland Revenue Tower | Architectural Services Department | 11/2020 |
| Second Expansion of DHL Central Asia Hub | DHL Express Hong Kong Ltd. | 12/2020 |
| Queen Elizabeth Hospital | Electrical and Mechanical Services Department | 12/2020 |
| NKIL6550 Cheung Sha Wan Hotel | Sun Hung Kai Properties Ltd | 01/2021 |
| Prince of Wales Hospital - Main Block – H, K, L, & M and Special Block – E & F | Hospital Authority | 01/2021 |
| NKIL6582 Cheung Sha Wan Office | New World Development | 02/2021 |
| No. 43 Island Road | Chong Hing Bank Limited | 02/2021 |
| HKIA C3723 Third Runway Eastern Support Area | Hong Kong International Airport | 03/2021 |
| Proposed New Dangerous Goods Store, The Chinese University of Hong Kong | The Chinese University of Hong Kong | 03/2021 |
| 136 Lei Nam Road & 232 Wan Chai Road | Logan Property Holdings Limited | 03/2021 |
| Shopping Centre at Elizabeth House | Cheung Kong Property Holdings Limited | 03/2021 |

| | | |
|---|--|---------|
| Elderly Centre at Ventris Road | Hong Kong Macau Conference Holding Limited | 03/2021 |
| To Shek Street, Shatin | Sun Hung Kai Properties Ltd | 03/2021 |
| IT Operations Building at Shatin Racecourse | The Hong Kong Jockey Club | 03/2021 |
| Good Hope School at Hei Fook Road | Good Hope School | 04/2021 |
| Regency Centre 1&2 at 41-43 Wong Chuk Hang Road | Ever Success Holdings Ltd | 04/2021 |
| 41 King Yip Street, Kwun Tong | Viva Properties Development Limited | 04/2021 |
| Kai Tak Sports Park | Architectural Services Department /New World Development | 05/2021 |
| C&E Dept at No. 57 Sheung Fung Street, Wong Tai Sin | Architectural Services Department | 06/2021 |
| New Academic Building at St. Stephen's College at Stanley | St. Stephen's College | 07/2021 |
| Light Rail Tin Wing Stop, Area 33 | Sun Hung Kai Properties Ltd/ MTRC | 07/2021 |
| NKIL6551 Kai Tak | Sun Hung Kai Properties Ltd | 08/2021 |
| Transitional Housing Development at Kong Ha Wai, Kam Tin | Pok Oi Hospital | 10/2021 |
| Kwu Tau North Development Area | Civil Engineering and Development Department | 12/2021 |
| Summit, Ocean Park | Ocean Park Corporation | 12/2021 |
| The Cliveden | Kerry Properties Limited | 01/2022 |
| Prince of Wales Hospital - Clinical Sciences Building, Trauma Centre & A/C Room at Prince of Wales Hospital | Hospital Authority | 01/2022 |
| Kai Tak Area 4C site 3, NKIL 6551 | Sun Hung Kai Properties Ltd | 01/2022 |
| Hotel Development at 62 -68 Chun Yeung Street, North Point | Vanke Property Agency Limited | 01/2022 |
| Jockey Club One Health Tower and A&A works for Academic Exchange Building at City University Lodge | City University of Hong Kong | 02/2022 |

| | | |
|---|-----------------------------------|---------|
| Proposed T.W.G. Hs Holistic Centre for youth Development at San Po Kong | Tung Wah Group of Hospitals | 03/2022 |
| Design & Construction of Immigration Headquarters in Area 67, Tseung Kwan O | Architectural Services Department | 03/2022 |
| Kai Tak Isolation Facilities | Architectural Services Department | 03/2022 |
| Siu Sai Wan Health Centre | Architectural Services Department | 03/2022 |
| RCP at Hung Yuen Road | Architectural Services Department | 03/2022 |
| 36 Wong Chuk Hang Road | Empire Group Ltd | 03/2022 |
| 22 Wang Yip Street West | Star Properties HK Ltd. | 04/2022 |
| Proposed Office Development at 2 Murray Road, Central | Henderson Land | 04/2022 |
| Shui On Centre | Shui On Centre | 05/2022 |
| Light Rail in Ting Wing Stop, TSWTL No. 23 Area 33, Tin Shui Wai | Sun Hung Kai Properties Ltd | 05/2022 |
| 7-9A Cheung Wah Street | Well Century Investments Ltd | 05/2022 |
| LOHAS 11 at TKO | Sino Land/ MTRC | 06/2022 |
| 14 Wang Tai Road | First Group Holdings Ltd | 06/2022 |
| 918 Cheung Sha Wan Road | First Group Holdings Ltd | 06/2022 |
| 926 Cheung Sha Wan Road | First Group Holdings Ltd | 06/2022 |
| Nexus Building | Jones Lang LaSalle, Inc. | 06/2022 |
| Multi-welfare Services Complex in Kwu Tung North | Architectural Services Department | 06/2022 |
| Community Health Centre and Social Welfare Facilities Building in Siu Sai Wan | Architectural Services Department | 07/2022 |
| Shui On Centre | Socam Development Ltd | 07/2022 |
| Hong Kong Baptist University | Hong Kong Baptist University | 07/2022 |

SIEMENS

| | | |
|---|--|---------|
| Lyric Theatre Complex | West Kowloon Cultural District | 08/2022 |
| The Communal, Lyric Theatre Complex | West Kowloon Cultural District | 09/2022 |
| Proposed Office Buildings & shopping mall at KIL 11262 West Kowloon Station | Sun Hung Kai Properties Ltd | 10/2022 |
| CLP Black Point Power Station, D2 | CLP Power Hong Kong Ltd. | 10/2022 |
| West Kowloon Express Railway Link Terminus Commercial Development | Sun Hung Kai Properties | 10/2022 |
| 37-43 Sha Tsui Road, Tsuen Wan | RealPlus Property Company Limited | 10/2022 |
| The Student Residence at Wong Chuk Hang Site, The University of Hong Kong | The University of Hong Kong | 11/2022 |
| Proposed Transitional Housing at Wong Yue Tang & Luen Yan Street | The Lok Sin Tong Benevolent Society, Kowloon | 11/2022 |
| Immigration Centre, Tseung Kwan O | Immigration Department | 11/2022 |
| Proposed Commercial Buildings at No. 7 Lai Yip Street, Kwun Tong | Henderson Land Development Co., Ltd | 12/2022 |
| Redevelopment of Kwai Chung Hospital (Phase 2) | Architectural Services Department | 12/2022 |
| Prince of Wales Hospital - Li Ka Shing Medical Sciences Building | Hospital Authority | 01/2023 |
| Hospital Authority Supporting Services Centre in North Lantau | Hospital Authority | 01/2023 |
| Proposed Residential Buildings at Yau Tong Lot 45 | Cheung Kong Property Holdings Ltd | 02/2023 |
| Upgrade of AFA system at Marine World, Ocean Park | Ocean Park Corporation | 03/2023 |
| Proposed Residential Building at YOHO Hub | Sun Hung Kai Properties Ltd | 04/2023 |
| Proposed Office Buildings at 14 Wang Tai Road, Kowloon Bay | First Group Holdings Ltd | 04/2023 |
| Central Kowloon Route - Yau Ma Tei East | Highways Department | 05/2023 |
| Proposed Residential Development at Kai Tak Area 4C, Site 3 | Sun Hung Kai Properties Ltd | 05/2023 |

SIEMENS

| | | |
|--|--|---------|
| Proposed Office Development AIA Tower | AIA International Ltd | 05/2023 |
| Proposed Residential Building at LOHAS 11, Tseung Kwan O | Sino Land Company Ltd | 06/2023 |
| Proposed Residential Building at Tai Wai Station | New World Development Co., Ltd | 06/2023 |
| Transitional Housing Project at DD106 Ngau Tam Mei, Yuen Long | Evangelical Lutheran Church Social Service Hong Kong | 07/2023 |
| Proposed residential Buildings at 53 Kwun Tong Road, Kwun Tong | One Link International Holdings, W. S. H. Group | 07/2023 |
| Transitional Housing Project at Ping Che Road, Ta Kwu Ling | Pok Oi Hospital | 07/2023 |
| Proposed Office Building at 20 Des Voeux Road, Central | Tak Shing Investment Co Ltd | 08/2023 |
| Proposed Data Centre at Chai Wan Kok Street & Ma Wo Road | Goodman Aisa Ltd | 08/2023 |
| High West Development, The University of Hong Kong | The University of Hong Kong | 09/2023 |
| Contract No. DE/201/04 Shek Wu Hui Effluent Polishing Plant - Main Works Stage 1 | Drainage Services Department | 10/2023 |
| VAC / SPS for GTWW Building 2 & 8, 23-33 Chai Wan Kok Street, Tsuen Wan | Goodman GTWW Investment No. 2 Ltd | 11/2023 |
| The Avignon | Sun Hung Kai Properties Ltd | 11/2023 |
| No. 6602 Ko Chiu Road, Yau Tong, Kowloon | Sino Land Co., Ltd | 12/2023 |
| VAC for Hospital Authority Supporting Services Centre in North Lantau | Hospital Authority | 01/2024 |
| Chinese Medicine Hospital | Health Bureau | 01/2024 |
| Proposed Residential Development at Discovery Bay Area N1 North | HKR International Ltd | 02/2024 |
| Proposed Residential Building at Tai Po | Vanke Holdings (HK) Co., Ltd | 02/2024 |

Town Lot 243

| | | |
|--|---|----------|
| Tung Chung Valley Phase 1 | Civil Engineering and Development Department | 03/2024 |
| Government Chinese Medicines Testing Institute in TKO | Chinese Medicine Regulatory Office | 03/2024 |
| Contract No. EM2003: Central Kowloon Route - Yau Ma Tei West | Highways Department | 03/2024 |
| Block BC, Block DE & Block F, Kwai Chung Hospital | Hospital Authority | 04/2024 |
| Temporary Transitional Housing Development at D.D. 128 & D.D. 129 and Adjoining Government Land, Lau Fau Shan, Yuen Long | Tung Wah Group of Hospital | 05/2024 |
| Joint-User Government Office Building in Area 67, TKO | Architectural Services Department | 05/ 2024 |
| Proposed Commercial Development on IL No. 8945 at Caroline Hill Road, Causeway Bay | Hysan Properties Ltd | 06/ 2024 |
| Waterfront Area, Ocean Park | Ocean Park Corporation | 07/2024 |
| Proposed Hong Kong Polytechnic University - Student Hostel at Tat Hong Avenue, Kowloon Tong | Hong Kong Polytechnic University | 08/ 2024 |
| Light Public Housing at Zone 1 & Zone 2 - Yau Pok Road, Phase 1 & Phase 2 - Choi Hing Road, Tuen Mun Area 3A | Architectural Services Department | 09/ 2024 |
| Proposed Residential Development at Tong San Tsuen, Yuen Long | Architectural Services Department | 10/ 2024 |
| Ventilation & Air Conditioning System Kai Tak Acute Hospital (Site B) | Architectural Services Department | 10/ 2024 |
| Transitional Housing at Shuen Wan, Off Ting Kok Road, Tai Po, N. T. | The Society of Rehabilitation and Crime Prevention, Hong Kong | 11/ 2024 |
| Design & Construction of the District Court at Caroline Hill Road | Architectural Services Department | 11/ 2024 |
| Science Park Expansion Stage 2 Building | Science Park | 12/ 2024 |
| Open space with Public Vehicle Park at Yen Chow Street West | Architectural Services Department | 12/ 2024 |

SIEMENS

| | | |
|---|-----------------------------------|----------|
| Kai Tak Acute Hospital (Site A) | Architectural Services Department | 01/ 2025 |
| Hong Kong International Arbitration Centre (The Headquarters for an International Organization) | Architectural Services Department | 01/ 2025 |