

Cerberus™ PRO

## Fire control panel

FC724



**Compact, pre-assembled fire control panel with integrated, user-friendly operating unit.**

- Fire control panel for max. 504 addresses
- Optional, integrated single-sector extinguishing
- Can be used as a standalone version or networked with up to 64 stations, such as control panels and terminals
- Redundant network node with degraded mode operation according to EN 54
- Option to connect to Siemens 'Cloud for Buildings'
- Emergency power supply for emergency operating time of up to 72 hours
- Recognition, automatic read-in and immediate operational readiness of all C-NET devices with auto-configuration
- Flexible configuration of complex applications and controls
- Configuration data can be uploaded/downloaded via remote access
- Time and situation-dependent changeover of detector parameter sets
- Extensions: Printer, key switches, LED indicators

System



The diagrams have been simplified and do not include additional network hardware or security components. Permissible applications are described in the A6V101039439 Network Security Guidelines document. Contact your Siemens IT security expert for more information.

System overview

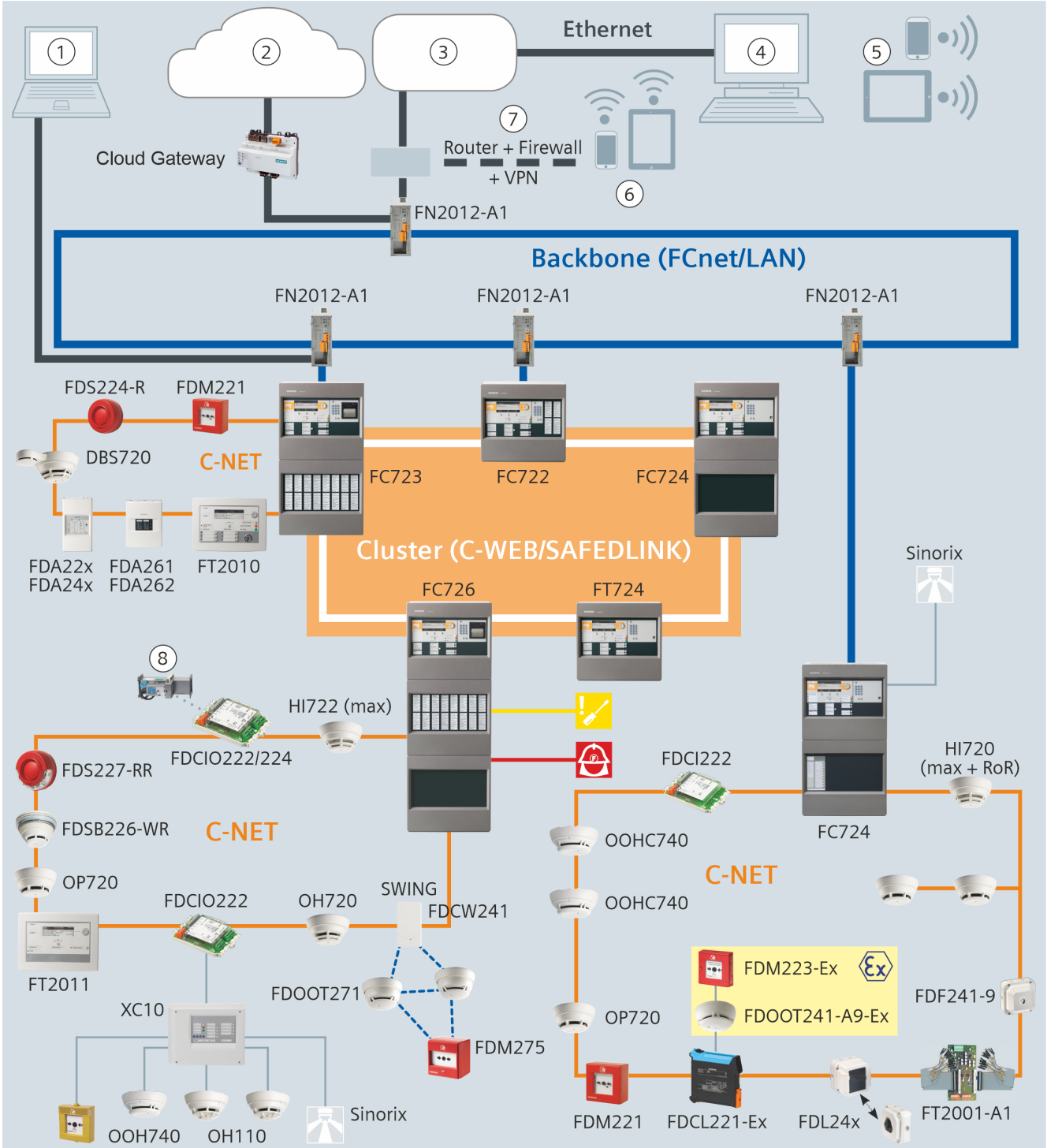



Fig. 1: System overview

1	Remote access with Cerberus-Remote
2	'Cloud for Buildings'
3	Customer network
4	Management platform
5	Remote access to management platform
6	Remote access with Cerberus Mobile
7	Router + firewall + virtual private network
8	Fire damper with actuator
	Transmission of a fault signal
	Transmission of an alarm signal

You will find a detailed labeled version of the diagram above along with further information in the A6V10332842 planning guide, see chapter 'Product documentation'.

## Networking of fire control panels



The diagrams have been simplified and do not include additional network hardware or security components. Permissible applications are described in the A6V101039439 Network Security Guidelines document. Contact your Siemens IT security expert for more information.

Up to 32 control panels and terminals can be linked to form one C-WEB network. If the C-WEB network is connected to a danger management system via BACnet, up to 16 control panels and terminals can be networked.

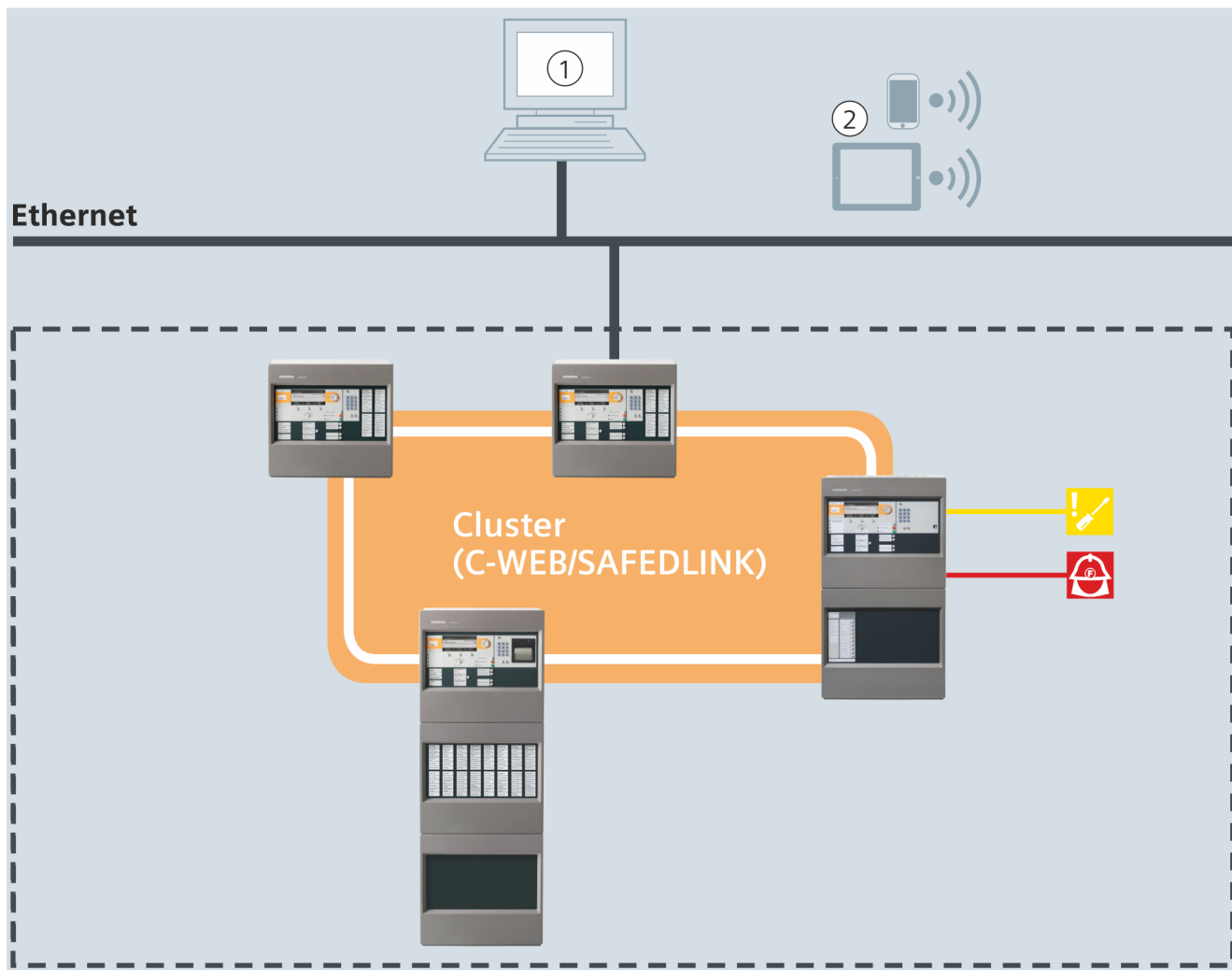

Fig. 2: Sub-net

1	Management platform
2	Remote access to management platform
	Transmission of a fault signal
	Transmission of an alarm signal

An optical C-WEB/LAN network allows up to 14 sub-nets with up to 16 stations to be operated in one network. A maximum of 64 stations is supported in total.

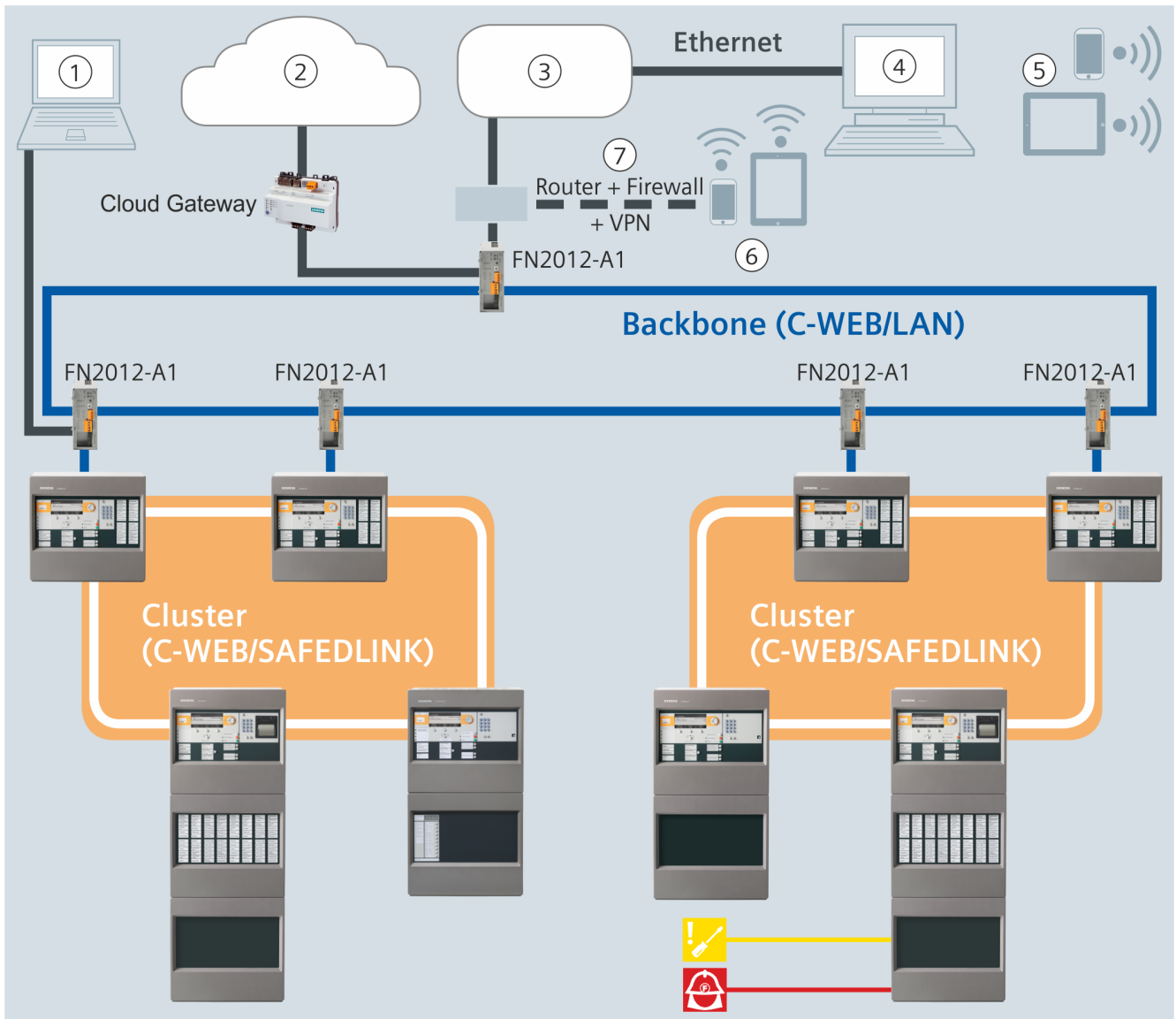



Fig. 3: Backbone

1	Remote access with Cerberman-Remote
2	'Cloud for Buildings'
3	Customer network
4	Management platform
5	Remote access to management platform
6	Remote access with Cerberman Mobile
7	Router + firewall + virtual private network
	Transmission of a fault signal
	Transmission of an alarm signal

You will find a detailed labeled version of the diagram above along with further information in the A6V10332842 planning guide, see chapter 'Product documentation'.

**General features and functions**

- Fast Ethernet interface for a heterogeneous network
- Processes the signals of the Cerberus PRO detector series FD720
- Floor repeater displays, terminals and alarm devices on the C-NET detector line with power supply via C-NET
- Interface to Siemens danger management system
- Slots for RS232 and RS485 serial interfaces
- All detector lines are monitored for ground faults
- Integrated degraded mode function
- Freely configurable, time-dependent controls with optional weekly, monthly, and yearly switching programs
- Time and situation-dependent changeover of detector parameter sets
- Controls for synchronous activation of sounder bases/sounders (acoustic, optical, language)
- The control panel and the fire detection system are custom-configured using the 'Cerberus-Engineering-Tool' software
- Firmware for all processor-controlled control panel components can be updated
- Customer texts can be adapted directly on the operating unit of the control panel or with the 'Cerberus-Engineering-Tool' software
- Up to 13000 events can be called up from the event memory and filtered based on various criteria
- Automatic summer/normal time changeover

**Control panel-specific features**





From IP8, the fire control panels can be ordered with a periphery board with a 0.5 A or 1.5 A output current per C-NET line.  
To convert existing fire control panels, the periphery board with 1.5 A per C-NET line can be ordered separately.



You will find information on the integrated extinguishing system and the individual extinguishing components that are available in a separate data sheet with the document ID 'A6V11480005'.

FC724-ZA	Housing (Comfort)
	<p>Detector line (C-NET)</p> <ul style="list-style-type: none"> <li>● 504 addresses</li> <li>● 4 loops/8 stubs</li> </ul> <p>Properties</p> <ul style="list-style-type: none"> <li>● Operating unit</li> <li>● Operating add-on (empty)</li> <li>● 150 W power supply</li> <li>● Max. battery capacity 25 Ah</li> <li>● 1 flooding zone (optional)</li> </ul> <p>Options of the operating unit</p> <ul style="list-style-type: none"> <li>● Event printer FTO2001-A1</li> <li>● Key switch (Kaba) FTO2005-C1</li> <li>● Key switch (nordic) FTO2006-B1</li> <li>● Operating add-on (2xLED indicator) FCM7213-Y3</li> <li>● Operating add-on (4xLED indicator) FCM7214-Y3</li> <li>● Exting. terminal (1 sector) XCM2002-A2</li> </ul>

FC724-ZAG	Housing (Comfort)
	<p>Detector line (C-NET)</p> <ul style="list-style-type: none"> <li>• 504 addresses</li> <li>• 4 loops/8 stubs</li> </ul> <p>Properties</p> <ul style="list-style-type: none"> <li>• Operating unit</li> <li>• Operating add-on (empty)</li> <li>• 150 W power supply</li> <li>• Connect X200 Gateway</li> <li>• Max. battery capacity 25 Ah</li> <li>• 1 flooding zone (optional)</li> </ul> <p>Options of the operating unit</p> <ul style="list-style-type: none"> <li>• Event printer FTO2001-A1</li> <li>• Key switch (Kaba) FTO2005-C1</li> <li>• Key switch (nordic) FTO2006-B1</li> <li>• Operating add-on (2xLED indicator) FCM7213-Y3</li> <li>• Operating add-on (4xLED indicator) FCM7214-Y3</li> <li>• Exting. terminal (1 sector) XCM2002-A2</li> </ul>





FC724-ZE	Housing (Comfort)
	<p>C-NET detector line:</p> <ul style="list-style-type: none"> <li>• 504 addresses</li> <li>• 4 loops/8 stubs</li> </ul> <p>Features:</p> <ul style="list-style-type: none"> <li>• Operating unit</li> <li>• Operating add-on (2xLED indicator)</li> <li>• 150 W power supply</li> <li>• Max. battery capacity 25 Ah</li> </ul> <p>Operating unit options:</p> <ul style="list-style-type: none"> <li>• Event printer FTO2001-A1</li> <li>• Key switch (Kaba) FTO2005-C1</li> <li>• Key switch (nordic) FTO2006-B1</li> </ul>

## Extensions

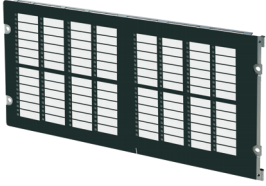

You will find information on the integrated extinguishing system and the individual extinguishing components that are available in a separate data sheet with the document ID 'A6V11480005'.

FCM7213-Y3	Operating add-on (2xLED indicator)
	<ul style="list-style-type: none"> <li>• Optional operating add-ons with 48 indicator groups and two LEDs each: 1x red/green LED and 1x yellow LED</li> </ul>

<p><b>FCM7214-Y3</b></p> 	<p><b>Operating add-on (4xLED indicator)</b></p> <ul style="list-style-type: none"> <li>Optional operating add-ons with 96 indicator groups and two LEDs each: 1x red/green LED and 1x yellow LED</li> </ul>
<p><b>FH7202-Z3</b></p> 	<p><b>Housing (Standard)</b></p> <ul style="list-style-type: none"> <li>Empty housing for free use</li> <li>443 x 404 x 188 mm</li> <li>E.g., for extra batteries, operating add-ons, or event printers</li> <li>Space for the following battery configuration: <ul style="list-style-type: none"> <li>– 2x FA2004-A1 (12 Ah)</li> </ul> </li> </ul>
<p><b>FH7203-Z3</b></p> 	<p><b>Housing (Comfort)</b></p> <ul style="list-style-type: none"> <li>Empty housing for free use</li> <li>443 x 802 x 188 mm</li> <li>E.g., for extra batteries, operating add-ons, or event printers</li> <li>Space for the following battery configurations: <ul style="list-style-type: none"> <li>– 2x FA2005-A1 (17 Ah) or</li> <li>– 2x BAT12-25 (25 Ah)</li> </ul> </li> <li>The mounting kit for the batteries FHA2061-A1 must be ordered separately.</li> </ul>
<p><b>FTO2001-A1</b></p> 	<p><b>Event printer</b></p> <ul style="list-style-type: none"> <li>Thermal printer for installation in operating units or operating add-ons</li> <li>Can be controlled via the RS232 module FCA2001-A1 (order separately)</li> <li>Logs all important events, such as alarms, faults, isolations, and test functions</li> </ul>
<p><b>DL3750+</b></p> 	<p><b>Matrix printer (external)</b></p> <ul style="list-style-type: none"> <li>External matrix printer recommended by Siemens</li> <li>Supports monitoring for printing faults</li> <li>Can be controlled via the RS232 module FCA2001-A1 (order separately)</li> <li>Can be controlled via Ethernet via the print server PS104 from SEH</li> </ul>

## Use

For medium-sized applications, e.g., for industrial plants, regional banks, or office complexes.

Also suitable for more comprehensive systems thanks to flexible networking options.

## Design

### Function elements

#### Operating unit

The following elements are available on the operating unit:

- CPU module and electronics
- Ethernet connection
- Slots for RS232 and RS485 modules and network modules (SAFEDLINK)
- Space for 'Kaba' or 'nordic' key switch
- Space for event printer (depending on version)
- Peripheral data bus connection for optional LED modules

#### Periphery board



From IP8, the fire control panels can be ordered with a periphery board with a 0.5 A or 1.5 A output current per C-NET line.

To convert existing fire control panels, the periphery board with 1.5 A per C-NET line can be ordered separately.

The following elements are available on the periphery board:

- Connection terminals for:
  - C-NET lines
  - Remote transmission (alarm, fault)
  - Horn output
  - Configurable control inputs and outputs
  - Monitored alarm and fault output
  - Power supply and emergency supply
- 2x slot for loop extension (C-NET)

#### Power supply unit 150 W, emergency power supply

The power supply feeds the hardware and charges the batteries.

In the event of a power cut, the batteries provide emergency current.

#### Housing

An FHA2007-A1 pivoting mounting plate can be fitted for the following elements above the periphery board on the rear housing panel:

- 1x fire brigade periphery module (for Germany)
- 2x sounder modules (as an alternative to mounting on U-rail TS35)
- 1x Connect X200 Gateway

#### Configuration

The following software allows the system to be customized:

- Cerberus-Engineering-Tool

## Operation

Each control unit has an integrated operating unit. The control panel can also be operated via a separate fire terminal FT724.

You will find details and more information in product data sheet A6V10207898.

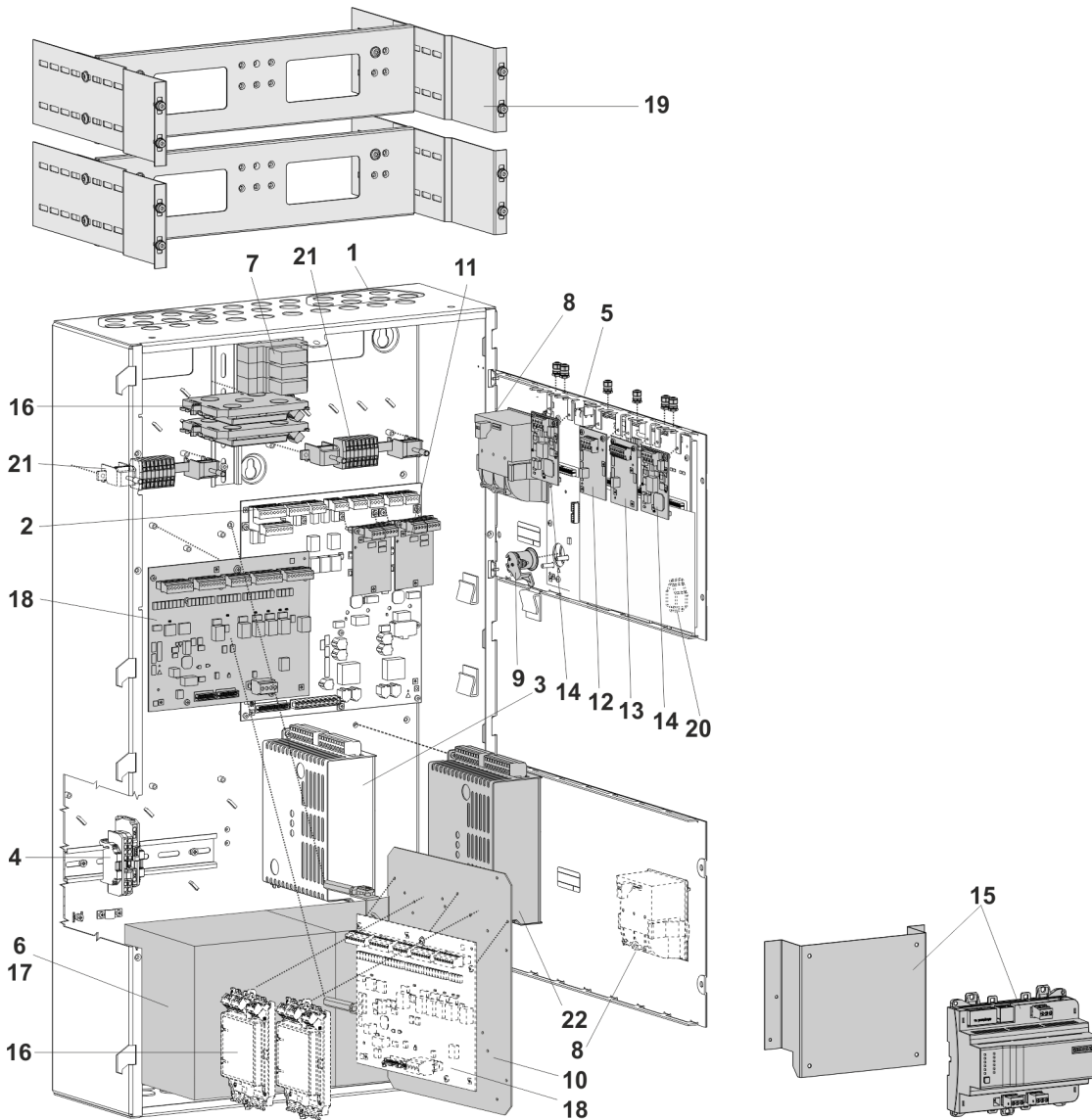

Fig. 4: Layout of FC724 Comfort

Position	Designation	Type	Comment
<b>Basic equipment</b>			
1	Housing (Comfort)	FH7203-Z3	Items 1-5: Basic equipment for each FC724-xx (Comfort).
2	Periphery board (4 loops) Periphery board (4 loops, P)	FCI2004-A1 FCI2024-A1	
3	Power supply (SV 24 V-150 W)	V24230-Z6-A5	The periphery board (4 loops, P) can be ordered separately to convert the station to the 1.5 A C-NET line.
4	Mains terminals on TS35 DIN rail	-	Space for socket, relay modules, etc.
5	Operating unit	FCM72x-xx	Operating unit with CPU
6	Space for batteries	-	2x 12 V / 25 Ah
<b>Extensions</b>			
7	Relay module	Z3B171	Relay for fire controls
8	Event printer	FTO2001-A1	For logging events
9	Key switch (Kaba)	FTO2005-C1	For operating access authorization
	Key switch (nordic)	FTO2006-B1	

Position	Designation	Type	Comment
10	Mounting plate	FHA2007-A1	e.g., for fire brigade periphery module or Connect X200 Gateway
11	Loop extension (C-NET)	FCI2003-A1	For loop extension of the periphery board (4 loops) FCI2004-A1 from two to four loops, number of addresses remains the same
	Loop extension (FDnet/C-NET, P)	FCI2025-A1	For loop extension of the periphery board (4 loops, P) FCI2024-A1 from two to four loops, number of addresses remains the same
12	RS485 module (isolated)	FCA2002-A1	For peripheral devices with RS485 interface
13	RS232 module (isolated)	FCA2001-A1	For devices with an RS232 interface
14	Network module (SAFEDLINK)	FN2001-A1	For networking several stations
15	Connect X200 Gateway and mounting plate (X200) FHA2063-A1	CXG3.X200	For connecting an FS720 station to Cloud for Buildings The mounting plate FHA2007-A1 and the accessory set + ACDC (X200) FCA2056-A1 or the mounting plate (X200) FHA2063-A1 and the accessory set + ACDC (X200) FCA2056-A1 must be ordered separately.
16	Sounder module	FCA2005-A1	For splitting one conventional sounder into four
17	Battery (12 V, 17 Ah, VdS)	FA2005-A1	For the emergency power supply
	Battery (12 V, 25 Ah, VdS)	BAT12-25	
18	Fire brigade periphery module	FCI2001-D1	For Germany (FBF, FSD, ÜE, FSE, ÖA, KL)
19	19" mounting kit	FHA2016-A1	For installation in 19" third-party housing
20	License key Sx	FCA20xx	For special functions
21	Cable kit (communication)	FCA2014-A1	For flexible connections running to the modules on the operating unit
22	Power supply kit (150 W, B)	FP2005-A1	For extra power supply
	Repeater (SAFEDLINK)	FN2002-A1	Not in overview, as not an installation part. For extending the system bus C-WEB from 1000 m to 2000 m between two stations. Max. 1x repeater (SAFEDLINK) between two stations

Housing (Comfort)



Type	FC724-ZA / FC724-ZAG	FC724-ZE
Number of C-NET addresses	504	
Number of lines:		
Loops (with loop extension) or	4 (8)	
Stubs (with loop extension)	8 (16)	
Power supply	150 W	
Max. battery capacity	25 Ah	
Indicator groups with one red/green and one yellow LED each	-	48

### Control panels

Type	Designation	Weight	Order number
FC724-ZA	Fire control panel (4 loops)	15.061 kg	S54400-C30-A2
FC724-ZA	Fire control panel (4 loops, P)	15.041 kg	S54433-C115-A1
FC724-ZAG	Fire control panel (4 loops, P, X200)	15.534 kg	S54400-C38-A1
FC724-ZE	Fire control panel (4 loops)	15.313 kg	S54400-C30-A3
FC724-ZE	Fire control panel (4 loops, P)	-	S54433-C115-A2

### Extensions



You will find information on the integrated extinguishing system and the individual extinguishing components that are available in a separate data sheet with the document ID 'A6V11480005'.

Type	Designation	Weight	Order number
FCA2001-A1	RS232 module (isolated)	0.033 kg	A5Q00005327
FCA2002-A1	RS485 module (isolated)	0.027 kg	A5Q00009923
FCA2005-A1	Sounder module	0.100 kg	A5Q00014866
FCA2014-A1	Cable kit (communication)	0.126 kg	A5Q00023027
FCI2003-A1	Loop extension (C-NET)	0.030 kg	A5Q00010136
FCI2024-A1	Periphery board (4-Loop, P)	0.119 kg	S54400-A184-A1
FCI2025-A1	Loop extension (FDnet/C-NET, P)	0.030 kg	S54400-A185-A1
FCM7213-Y3	Operating add-on (2xLED indicator)	2.516 kg	S54400-B149-A1
FCM7214-Y3	Operating add-on (4xLED indicator)	3.905 kg	S54400-B150-A1
FH7202-Z3	Housing (Standard)	7.268 kg	S54400-B70-A1
FH7203-Z3	Housing (Comfort)	12.874 kg	S54400-B71-A1
FHA2007-A1	Mounting plate	0.800 kg	A5Q00010151
FHA2016-A1	19" mounting kit	3.000 kg	A5Q00020179
FN2001-A1	Network module (SAFEDLINK)	0.022 kg	A5Q00012851
FN2002-A1	Repeater (SAFEDLINK)	0.105 kg	S24236-B2502-A1
FN2006-A1	Fiber network module (SM)	0.792 kg	S54400-A109-A1
FN2007-A1	Fiber network module (MM)	0.792 kg	S54400-A110-A1
FTO2001-A1	Event printer	0.141 kg	A5Q00010126
-	Spare printer reels (10 reels)	0.090 kg	A5Q00017619
FTO2005-C1	Key switch (Kaba)	0.083 kg	A5Q00010113
FTO2006-B1	Key switch (nordic)	0.046 kg	A5Q00010129
Z3B171	Relay module 250 V AC / 10 A (1 relay)	0.042 kg	4843830001

### Auxiliary power supply

Type	Designation	Weight	Order number
FP2015-A1	Power supply (70 W) for EN-compliant installation in empty housing	1.300 kg	S54400-B121-A1

Type	Designation	Weight	Order number
FP2004-A1	Power supply kit (150 W, A) for EN-compliant installation in empty housing	1.286 kg	A5Q00020825
FP2005-A1	Power supply kit (150 W, B) for extension	1.181 kg	A5Q00018779

### Network (backbone)

Type	Designation	Weight	Order number
FCA2031-A1	Connection module (MoNet)	0.081 kg incl. cable	S54400-A153-A1
FHA2029-A1	Mounting kit (switch)	1.261 kg	S54400-B79-A1
FN2012-A1	Ethernet switch (modular)	0.600 kg	S54400-B152-A1
VN2002-A1	Ethernet module (MM)	0.026 kg	S54400-A43-A1
VN2003-A1	Ethernet module (SM)	0.026 kg	S54400-A44-A1

### Cloud Gateway

Type	Designation	Weight	Order number
CXG3.X200	Connect X200 Gateway	0.300 kg	S55842-Z131-A100
FCA2056-A1	Accessory kit + ACDC (X200)	0.200 kg	S54400-S115-A1
FHA2063-A1	Mounting plate (X200)	0.269 kg	S54400-B116-A1

### Batteries

Type	Designation	Weight	Order number
FA2004-A1	Battery (12 V, 12 Ah, VdS)	3.750 kg	A5Q00019354
FA2005-A1	Battery (12 V, 17 Ah, VdS)	5.700 kg	A5Q00019677
BAT12-25	Battery (12 V, 25 Ah, VdS)	7.8 kg	S54302-Z102-A1
FHA2061-A1	Mounting kit for batteries	–	S54400-B91-A1

### License keys

Type	Designation	Weight	Order number
FCA2033-A1	License key (S1)	0.010 kg	S54400-P154-A1
FCA2034-A1	License key (S2)	0.010 kg	S54400-P155-A1
FCA2035-A1	License key (S3)	0.010 kg	S54400-P156-A1
FCA2036-A1	License key (S4)	0.010 kg	S54400-P157-A1

### External printer

Type	Designation	Weight	Order number
DL3750+	Matrix printer (external)	7.300 kg	A5Q00023962
-	Color ribbon for matrix printer DL3750+	0.078 kg	A5Q00023963

Title	Document ID
<b>System documentation</b>	
System description	A6V10210355
Product data	A6V10210368
Planning	A6V10210362
Mounting/Installation	A6V10210390
<b>System data sheet</b>	
FS720 – Fire detection system	A6V10227649
<b>Data sheets</b>	
FC721 - fire control panel	A6V10203220
FC722 - fire control panel	A6V10206525
FC723 - fire control panel for modernization	A6V10379246
FC724 - fire control panel	A6V10207176
FC726 - fire control panel (modular)	A6V10263277
FT724 - fire terminal	A6V10207898
Fire detection system with integrated single-sector extinguishing	A6V11480005
Network Security Guidelines	A6V101039439
Planning overview	A6V10332842

Related documents such as the environmental declarations, CE declarations, etc., can be downloaded from the following Internet address:

[www.siemens.com/bt/download](http://www.siemens.com/bt/download)



## Guarantee

The application-specific technical data is guaranteed only in combination with the Siemens products listed in the 'Device combinations' section. If third-party products are used, any guarantee provided by Siemens will be invalidated.

## Technical data

### Fire control panel (4 loops)/(4 loops, P) FC724 in housing (Comfort)

<b>Supply</b>	Mains voltage	AC 115 / 230 V +10/-15 %
	Power supply	150 W
	Operating voltage	DC 21...28.4 V
	Operating current	Max. 5 A
	Battery capacity	2x 12 V, max. 25 Ah
	Battery monitoring	Yes
	Network monitoring	Yes
<b>Inputs / outputs</b>	Connectable detector series	Cerberus PRO (C-NET )
	Number of addresses	Max. 504
	Number of integrated line cards	2
	Number of lines:	
	• Loops (with loop extension) or	4 (8)
	• Stubs (with loop extension)	8 (16)
	Integrated inputs/outputs:	
	• Alarm RT relay output	1
	• Fault RT relay output	1
	• Monitored alarm outputs	1
• Monitored fault outputs	1	
• Monitored horn outputs	2	
• Freely configurable inputs/outputs	12	
<b>Interfaces</b>	Operating unit	Integrated
	Slots for serial interfaces RS232, RS485	2
	Slots for network modules	2
	Slot for loop extension	2
	Mounting space for cable kit (communication)	2
	Sounder module	Max. 2
	Ethernet port RJ45	1
<b>Ambient conditions</b>	Operating temperature	-8...+42 °C
	Storage temperature	-20...+60 °C
	Air humidity (no condensation permitted)	≤95 % rel.
	Maximum height above sea level	3,700 m
<b>Mechanical data</b>	Dimensions (W x H x D):	
	• Without cover cap	430 x 796 x 165 mm
	• With cover cap	443 x 802 x 188 mm
	Protection category (IEC 60529)	IP30
	Color:	
	• Housing	~RAL 7035 light gray
• Cover cap	~RAL 000 50 00	

Fire control panel (4 loops)/(4 loops, P) FC724 in housing (Comfort)		
<b>Approvals</b>	VdS	G209077
	LPCB	126bn/07
	FM	3051081
	DNV GL (marine)	MEDB00003US, see document A6V10339425

Issued by  
Siemens Switzerland Ltd  
Smart Infrastructure  
Global Headquarters  
Theilerstrasse 1a  
CH-6300 Zug  
+41 58 724 2424  
[www.siemens.com/buildingtechnologies](http://www.siemens.com/buildingtechnologies)

© Siemens 2007  
Technical specifications and availability subject to change without notice.

---

Document ID    A6V10207176\_m\_en\_--  
Edition        2023-07-06

## Certificate of Product Approval

Certificate Number: 126bn

Issue: 05

### Siemens Switzerland Ltd

Theilerstrasse 1a  
CH-6300 Zug  
Switzerland



is certified by BRE Global Ltd. and is authorised to use the LPCB mark in association with the product(s) listed in this certificate and appendix having complied with the requirement(s) of the standards as detailed below:

#### Products

##### Control & Indicating Equipment

~~FC2020, FC2030, FC2040,~~  
~~FC2060, FC721, FC722,~~  
~~FC724, FC726, FC723,~~  
~~FT2040, FT724~~

(refer to Appendix for details)

#### Standards

**EN 54-2:1997 + A1:2006**

**EN 54-4:1997 + A1:2002 + A2:2006**

This Certificate is maintained and held in force through regular surveillance activities and subject to the corresponding ISO 9001 Certificate being maintained.

Signed for BRE Global Ltd

E Mattie-Suleiman

Verifier

8 March 2019

Date of Issue

25 May 2016

Date of First Issue



This certificate and appendix remains the property of BRE Global Ltd. and is issued subject to terms and conditions (for details visit [www.redbooklive.com/terms](http://www.redbooklive.com/terms)).

To check the validity of this certificate and appendix please visit [www.redbooklive.com/check](http://www.redbooklive.com/check), scan the QR tag or contact us.

BRE Global Ltd, Watford, WD25 9XX  
T: +44 (0)333 321 8811 E: [enquiries@breglobal.com](mailto:enquiries@breglobal.com)

LPCB is a Registered Trademark of the Building Research Establishment Ltd.



## Appendix to Certificate No: 126bn

Issue: 05

### Siemens Switzerland Ltd

Certified Product	Description	LPCB Ref.No.
FC2020	Control and Indicating Equipment  Incorporating as modular units: FCM2027 PMI- & Mainboard FCM2028-A2 Operating unit FCM2037-A2 Operating unit (w/o accs.) FP2015-A1 70W Power supply FCI2002-A1 Periphery board (2-Loop)  and as optional modular units: FCA2001-A1 RS232 Module (isolated) FCA2002-A1 RS485 Module (isolated) FCA2031-A1 Connection Module (MoNet) FCI2001-D1 Fire brigade periphery module FCI2003-A1 Loop expansion (FDnet) FCM2036-A2 Operating add-on (4xLED indication) FCM2038-A2 Operating add-on (2xLED indication) FN2001-A1 Network module (SAFEDLINK) (See note 1) FN2008-A1 Ethernet Switch (MM) (see note 1) FN2012-A1 Ethernet Switch (modular) FTO2001-A1 Event printer set FTO2008-A1 LED module SV24V-150W Power Supply VN2002-A1 Ethernet module (MM) VN2003-A1 Ethernet module (SM)	126bn/01

This Certificate is maintained and held in force through regular surveillance activities and subject to the corresponding ISO 9001 Certificate being maintained.

  
Signed for BRE Global Ltd

E Mattie-Suleiman  
Verifier

8 March 2019  
Date of Issue

25 May 2016  
Date of First Issue



This certificate and appendix remains the property of BRE Global Ltd. and is issued subject to terms and conditions (for details visit [www.redbooklive.com/terms](http://www.redbooklive.com/terms)).

To check the validity of this certificate and appendix please visit [www.redbooklive.com/check](http://www.redbooklive.com/check), scan the QR tag or contact us.

BRE Global Ltd, Watford, WD25 9XX  
T: +44 (0)333 321 8811 E: [enquiries@breglobal.com](mailto:enquiries@breglobal.com)

LPCB is a Registered Trademark of the Building Research Establishment Ltd.



## Appendix to Certificate No: 126bn

Issue: 05

### Siemens Switzerland Ltd

Certified Product	Description	LPCB Ref.No.
	FHA2002-A1 Rear housing standard FHA2003-A1 Rear Housing Comfort  Certified with the following Options with requirements from EN 54-2: 7.8 Output to fire alarm devices 7.9.1 Output to fire alarm routing equipment 7.9.2 Alarm Confirmation from fire alarm routing equipment 7.10.1 Output to automatic fire protection equipment Type A 7.10.2 Output to automatic fire protection equipment Type B 7.10.3 Output to automatic fire protection equipment Type C 7.10.4 Fault monitoring of automatic fire protection Equipment 7.11 Delays to outputs 7.12.2 Dependencies on more than one alarm signal type B (only for FDnet- & MS9i-line technology) 7.12.3 Dependencies on more than one alarm signal type C 7.13 Alarm counter 8.3 Fault signals from points 8.9 Output to fault warning routing equipment 9.5 Disablement of addressable points 10 Test condition  Notes: 1. Scope of approval does not include the operation of the network functionality. 2. This approval does not constitute compliance with the fire detection and alarm systems requirements of EN 54-13.	

This Certificate is maintained and held in force through regular surveillance activities and subject to the corresponding ISO 9001 Certificate being maintained.



Signed for BRE Global Ltd

E Mattie-Suleiman  
Verifier

8 March 2019  
Date of Issue

25 May 2016  
Date of First Issue



This certificate and appendix remains the property of BRE Global Ltd. and is issued subject to terms and conditions (for details visit [www.redbooklive.com/terms](http://www.redbooklive.com/terms)).

To check the validity of this certificate and appendix please visit [www.redbooklive.com/check](http://www.redbooklive.com/check), scan the QR tag or contact us.

BRE Global Ltd, Watford, WD25 9XX  
T: +44 (0)333 321 8811 E: [enquiries@breglobal.com](mailto:enquiries@breglobal.com)

LPCB is a Registered Trademark of the Building Research Establishment Ltd.



## Appendix to Certificate No: 126bn

Issue: 05

### Siemens Switzerland Ltd

Certified Product	Description	LPCB Ref.No.
FC2030	Control and Indicating Equipment  Incorporating as modular units: FCM2027 PMI- & Mainboard FCM2028-A2 Operating unit FCM2037-A2 Operating unit (w/o accs.) SV24V-150W 150W Power supply FCI2002-A1 Periphery board (2-Loop) FCA2007-A1 Card cage (2 slot)  and as optional modular units: FCA2001-A1 RS232 Module (isolated) FCA2002-A1 RS485 Module (isolated) FCA2006-A1 Connection mod. (card cage) FCA2007-A1 Card cage FCA2031-A1 Connection Module (MoNet) FCI2001-D1 Fire brigade periphery module FCI2003-A1 Loop expansion (Fdnet) FCI2007-A1 I/O Card RT FCI2008-A1 I/O Card (programmable) FCI2009-A1 I/O Card Horn FCL2001-A1 Line Card (Fdnet) FCL2002-A1 Line Card (collective) FCL2003-A1 Line Card (MS9i) FCL2005-A1 Linecard (AnalogPlus)	126bn/02

This Certificate is maintained and held in force through regular surveillance activities and subject to the corresponding ISO 9001 Certificate being maintained.



Signed for BRE Global Ltd

E Mattie-Suleiman  
Verifier

8 March 2019  
Date of Issue

25 May 2016  
Date of First Issue



This certificate and appendix remains the property of BRE Global Ltd. and is issued subject to terms and conditions (for details visit [www.redbooklive.com/terms](http://www.redbooklive.com/terms)).

To check the validity of this certificate and appendix please visit [www.redbooklive.com/check](http://www.redbooklive.com/check), scan the QR tag or contact us.

BRE Global Ltd, Watford, WD25 9XX  
T: +44 (0)333 321 8811 E: [enquiries@breglobal.com](mailto:enquiries@breglobal.com)

LPCB is a Registered Trademark of the Building Research Establishment Ltd.



## Appendix to Certificate No: 126bn

Issue: 05

### Siemens Switzerland Ltd

Certified Product	Description	LPCB Ref.No.
FCL2006-A1	Linecard (Interactive)	
FCL2007-A1	Linecard (InteractiveEx)	
FCM2036-A2	Operating addition (4 xLED indication)	
FCM2015-D1	Operating add-on (DA ind)	
FCM2036-A2	Operating add-on (4xLED indication)	
FCM2038-A2	Operating add-on (2xLED indication)	
FN2001-A1	Network module (SAFEDLINK) ( See note 1)	
FN2008-A1	Ethernet Switch (MM) (see note 1)	
FN2012-A1	Ethernet Switch (modular)	
FTO2001-A1	Event printer set	
FTO2008-A1	LED module	
VN2002-A1	Ethernet module (MM)	
VN2003-A1	Ethernet module (SM)	
FC2030-CR	Housing Rear (CH)	
FHA2003-A1	Rear housing comfort	
<p>Certified with the following Options with requirements from EN 54-2:</p> <ul style="list-style-type: none"> <li>7.8 Output to fire alarm devices</li> <li>7.9.1 Output to fire alarm routing equipment</li> <li>7.9.2 Alarm Confirmation from fire alarm routing equipment</li> <li>7.10.1 Output to automatic fire protection equipment Type A</li> <li>7.10.2 Output to automatic fire protection equipment Type B</li> <li>7.10.3 Output to automatic fire protection equipment Type C</li> <li>7.10.4 Fault monitoring of automatic fire protection Equipment</li> <li>7.11 Delays to outputs</li> </ul>		

This Certificate is maintained and held in force through regular surveillance activities and subject to the corresponding ISO 9001 Certificate being maintained.



Signed for BRE Global Ltd

E Mattie-Suleiman  
Verifier

8 March 2019  
Date of Issue

25 May 2016  
Date of First Issue



This certificate and appendix remains the property of BRE Global Ltd. and is issued subject to terms and conditions (for details visit [www.redbooklive.com/terms](http://www.redbooklive.com/terms)).

To check the validity of this certificate and appendix please visit [www.redbooklive.com/check](http://www.redbooklive.com/check), scan the QR tag or contact us.

BRE Global Ltd, Watford, WD25 9XX  
T: +44 (0)333 321 8811 E: [enquiries@breglobal.com](mailto:enquiries@breglobal.com)

LPCB is a Registered Trademark of the Building Research Establishment Ltd.



## Appendix to Certificate No: 126bn

Issue: 05

### Siemens Switzerland Ltd

Certified Product	Description	LPCB Ref.No.
	7.12.1 Dependencies on more than one alarm signal type A (only for MS9i-, collective-, AnalogPlus-, Interactive - & InteractiveEx-line Technology) 7.12.2 Dependencies on more than one alarm signal type B 7.12.3 Dependencies on more than one alarm signal type C 7.13 Alarm counter 8.3 Fault signals from points 8.9 Output to fault warning routing equipment 9.5 Disablement of addressable points 10 Test condition  Notes: 1. Scope of approval does not include the operation of the network functionality. 2. This approval does not constitute compliance with the fire detection and alarm systems requirements of EN 54-13.	
FC2040	Control and Indicating Equipment  Incorporating as modular units; FCM2027 PMI- & Mainboard FCM2028-A2 Operating unit FCM2037-A2 Operating unit (w/o accs.) SV24V-150W 150W Power supply FCI2004-A1 Periphery board (4-Loop)  and as optional modular units: FCA2001-A1 RS232 Module ( isolated)	126bn/03

This Certificate is maintained and held in force through regular surveillance activities and subject to the corresponding ISO 9001 Certificate being maintained.

  
Signed for BRE Global Ltd

E Mattie-Suleiman  
Verifier

8 March 2019  
Date of Issue

25 May 2016  
Date of First Issue



This certificate and appendix remains the property of BRE Global Ltd. and is issued subject to terms and conditions (for details visit [www.redbooklive.com/terms](http://www.redbooklive.com/terms)).

To check the validity of this certificate and appendix please visit [www.redbooklive.com/check](http://www.redbooklive.com/check), scan the QR tag or contact us.

BRE Global Ltd, Watford, WD25 9XX  
T: +44 (0)333 321 8811 E: [enquiries@breglobal.com](mailto:enquiries@breglobal.com)

LPCB is a Registered Trademark of the Building Research Establishment Ltd.



## Appendix to Certificate No: 126bn

Issue: 05

### Siemens Switzerland Ltd

Certified Product	Description	LPCB Ref.No.
FCA2002-A1	RS485 Module ( isolated)	
FCA2031-A1	Connection Module (MoNet)	
FCI2001-D1	Fire brigade periphery module	
FCI2003-A1	Loop expansion (Fdnet)	
FCM2036-A2	Operating add-on (4xLED indication) optional	
FCM2038-A2	Operating add-on (2xLED indication) optional	
FN2001-A1	Network module (SAFEDLINK) (See note 1)	
FN2008-A1	Ethernet Switch (MM) (see note 1)	
FN2012-A1	Ethernet Switch (modular)	
FTO2001-A1	Event printer set	
FTO2008-A1	LED module	
VN2002-A1	Ethernet module (MM)	
VN2003-A1	Ethernet module (SM)	
FHA2003-A1	Rear housing comfort	
FHA2005-A1	Rear Housing Large	
<p>Certified with the following Options with requirements from EN 54-2:</p> <ul style="list-style-type: none"> <li>7.8 Output to fire alarm devices</li> <li>7.9.1 Output to fire alarm routing equipment</li> <li>7.9.2 Alarm Confirmation from fire alarm routing equipment</li> <li>7.10.1 Output to automatic fire protection equipment Type A</li> <li>7.10.2 Output to automatic fire protection equipment Type B</li> <li>7.10.3 Output to automatic fire protection equipment Type C</li> <li>7.10.4 Fault monitoring of automatic fire protection Equipment</li> <li>7.11 Delays to output</li> </ul>		

This Certificate is maintained and held in force through regular surveillance activities and subject to the corresponding ISO 9001 Certificate being maintained.



Signed for BRE Global Ltd

E Mattie-Suleiman  
Verifier

8 March 2019  
Date of Issue

25 May 2016  
Date of First Issue



This certificate and appendix remains the property of BRE Global Ltd. and is issued subject to terms and conditions (for details visit [www.redbooklive.com/terms](http://www.redbooklive.com/terms)).

To check the validity of this certificate and appendix please visit [www.redbooklive.com/check](http://www.redbooklive.com/check), scan the QR tag or contact us.

BRE Global Ltd, Watford, WD25 9XX  
T: +44 (0)333 321 8811 E: [enquiries@breglobal.com](mailto:enquiries@breglobal.com)

LPCB is a Registered Trademark of the Building Research Establishment Ltd.



## Appendix to Certificate No: 126bn

Issue: 05

### Siemens Switzerland Ltd

Certified Product	Description	LPCB Ref.No.
	7.12.2 Dependencies on more than one alarm signal type B (only for FDnet- & MS9i-line Technology) 7.12.3 Dependencies on more than one alarm signal type C 7.13 Alarm counter 8.3 Fault signals from points 8.9 Output to fault warning routing equipment 9.5 Disablement of addressable points 10 Test condition  Notes: 1. Scope of approval does not include the operation of the network functionality. 2. This approval does not constitute compliance with the fire detection and alarm systems requirements of EN 54-13.	
FC2060	Control and Indicating Equipment  Incorporating as modular units: FCM2027 PMI- & Mainboard FCM2028-A2 Operating unit FCM2037-A2 Operating unit (w/o accs.) SV24V-150W 150W Power supply FCI2004-A1 Periphery board (4-Loop) FCA2008-A1 Card cage (5 slot)  and as optional modular units: FCA2001-A1 RS232 Module ( isolated) FCA2002-A1 RS485 Module ( isolated)	126bn/04

This Certificate is maintained and held in force through regular surveillance activities and subject to the corresponding ISO 9001 Certificate being maintained.



Signed for BRE Global Ltd

E Mattie-Suleiman

Verifier

8 March 2019

Date of Issue

25 May 2016

Date of First Issue



This certificate and appendix remains the property of BRE Global Ltd. and is issued subject to terms and conditions (for details visit [www.redbooklive.com/terms](http://www.redbooklive.com/terms)).

To check the validity of this certificate and appendix please visit [www.redbooklive.com/check](http://www.redbooklive.com/check), scan the QR tag or contact us.

BRE Global Ltd, Watford, WD25 9XX  
 T: +44 (0)333 321 8811 E: [enquiries@breglobal.com](mailto:enquiries@breglobal.com)

LPCB is a Registered Trademark of the Building Research Establishment Ltd.



## Appendix to Certificate No: 126bn

Issue: 05

### Siemens Switzerland Ltd

Certified Product	Description	LPCB Ref.No.
FCA2006-A1	Connection mod. (card cage)	
FCA2008-A1	Card cage (5 slot)	
FCA2031-A1	Connection Module (MoNet)	
FCI2001-D1	Fire brigade periphery module	
FCI2003-A1	Loop expansion (FDnet)	
FCI2004-A1	Periphery board 4 loop	
FCI2007-A1	I/O Card RT	
FCI2008-A1	I/O Card (programmable)	
FCI2009-A1	I/O Card Horn	
FCL2001-A1	Line Card (FDnet)	
FCL2002-A1	Line Card (collective)	
FCL2003-A1	Line Card (MS9i)	
FCL2005-A1	Linecard (AnalogPlus)	
FCL2006-A1	Linecard (Interactive)	
FCL2007-A1	Linecard (InteractiveEx)	
FCM2036-A2	Operating add-on (4xLED indication)	
FCM2038-A2	Operating add-on (2xLED indication)	
FN2001-A1	Network module (SAFEDLINK) (See note 1)	
FN2008-A1	Ethernet Switch (MM) (see note 1)	
FN2012-A1	Ethernet Switch (modular)	
FTO2001-A1	Event printer set	
FTO2003-D1	LED emergency alarm indicator	
FTO2008-A1	LED module	
VN2002-A1	Ethernet module (MM)	
VN2003-A1	Ethernet module (SM)	

This Certificate is maintained and held in force through regular surveillance activities and subject to the corresponding ISO 9001 Certificate being maintained.



Signed for BRE Global Ltd

E Mattie-Suleiman  
Verifier

8 March 2019  
Date of Issue

25 May 2016  
Date of First Issue



This certificate and appendix remains the property of BRE Global Ltd. and is issued subject to terms and conditions (for details visit [www.redbooklive.com/terms](http://www.redbooklive.com/terms)).

To check the validity of this certificate and appendix please visit [www.redbooklive.com/check](http://www.redbooklive.com/check), scan the QR tag or contact us.

BRE Global Ltd, Watford, WD25 9XX  
T: +44 (0)333 321 8811 E: [enquiries@breglobal.com](mailto:enquiries@breglobal.com)

LPCB is a Registered Trademark of the Building Research Establishment Ltd.



## Appendix to Certificate No: 126bn

Issue: 05

### Siemens Switzerland Ltd

Certified Product	Description	LPCB Ref.No.
	<p>FHA2005-A1 Rear housing large</p> <p>Certified with the following Options with requirements from EN 54-2:</p> <ul style="list-style-type: none"> <li>7.8 Output to fire alarm devices</li> <li>7.9.1 Output to fire alarm routing equipment</li> <li>7.9.2 Alarm Confirmation from fire alarm routing equipment</li> <li>7.10.1 Output to automatic fire protection equipment Type A</li> <li>7.10.2 Output to automatic fire protection equipment Type B</li> <li>7.10.3 Output to automatic fire protection equipment Type C</li> <li>7.10.4 Fault monitoring of automatic fire protection equipment</li> <li>7.11 Delays to outputs</li> <li>7.12.1 Dependencies on more than one alarm signal type A (only for MS9i-, collective-, AnalogPlus-, Interactive - &amp; InteractiveEx-line Technology)</li> <li>7.12.2 Dependencies on more than one alarm signal type B</li> <li>7.12.3 Dependencies on more than one alarm signal type C</li> <li>7.13 Alarm counter</li> <li>8.3 Fault signals from points</li> <li>8.9 Output to fault warning routing equipment</li> <li>9.5 Disablement of addressable points</li> <li>10 Test condition</li> </ul> <p>Notes:</p> <ol style="list-style-type: none"> <li>1. Scope of approval does not include the operation of the network functionality.</li> <li>2. This approval does not constitute compliance with the fire detection and alarm systems requirements of EN 54-13.</li> </ol>	

This Certificate is maintained and held in force through regular surveillance activities and subject to the corresponding ISO 9001 Certificate being maintained.

  
Signed for BRE Global Ltd

E Mattie-Suleiman  
Verifier

8 March 2019  
Date of Issue

25 May 2016  
Date of First Issue



This certificate and appendix remains the property of BRE Global Ltd. and is issued subject to terms and conditions (for details visit [www.redbooklive.com/terms](http://www.redbooklive.com/terms)).

To check the validity of this certificate and appendix please visit [www.redbooklive.com/check](http://www.redbooklive.com/check), scan the QR tag or contact us.

BRE Global Ltd, Watford, WD25 9XX  
T: +44 (0)333 321 8811 E: [enquiries@breglobal.com](mailto:enquiries@breglobal.com)

LPCB is a Registered Trademark of the Building Research Establishment Ltd.



## Appendix to Certificate No: 126bn

Issue: 05

### Siemens Switzerland Ltd

Certified Product	Description	LPCB Ref.No.
FC721	<p>Control and Indicating Equipment</p> <p>Incorporating as modular units:</p> <p>FCM7204-Z3 Operating unit</p> <p>FCM7215-Y3 Operating unit (w/o acces.)</p> <p>FP2015-A1 70W Power supply</p> <p>FCI2010-A1 Periphery board (1-Loop)</p> <p>FCM2027 PMI- &amp; Mainboard</p> <p>and as optional modular units:</p> <p>FCA2001-A1 RS232 Module (isolated)</p> <p>FCA2002-A1 RS485 Module (isolated)</p> <p>FCM7213-Y3 Operating add-on (2xLED indication)</p> <p>FCM7214-Y3 Operating add-on (4xLED indication)</p> <p>FTO2001-A1 Event printer set</p> <p>FTO2008-A1 LED module</p> <p>FHA2001-A1 Rear Housing (Eco)</p> <p>Certified with the following Options with requirements from EN 54-2:</p> <p>7.8 Output to fire alarm devices</p> <p>7.9.1 Output to fire alarm routing equipment</p> <p>7.9.2 Alarm Confirmation from fire alarm routing equipment</p> <p>7.10.1 Output to automatic fire protection equipment Type A</p> <p>7.10.2 Output to automatic fire protection equipment Type B</p> <p>7.10.3 Output to automatic fire protection equipment Type C</p>	126bn/05

This Certificate is maintained and held in force through regular surveillance activities and subject to the corresponding ISO 9001 Certificate being maintained.



Signed for BRE Global Ltd

E Mattie-Suleiman  
Verifier

8 March 2019  
Date of Issue

25 May 2016  
Date of First Issue



This certificate and appendix remains the property of BRE Global Ltd. and is issued subject to terms and conditions (for details visit [www.redbooklive.com/terms](http://www.redbooklive.com/terms)).

To check the validity of this certificate and appendix please visit [www.redbooklive.com/check](http://www.redbooklive.com/check), scan the QR tag or contact us.

BRE Global Ltd, Watford, WD25 9XX  
T: +44 (0)333 321 8811 E: [enquiries@breglobal.com](mailto:enquiries@breglobal.com)

LPCB is a Registered Trademark of the Building Research Establishment Ltd.



## Appendix to Certificate No: 126bn

Issue: 05

### Siemens Switzerland Ltd

Certified Product	Description	LPCB Ref.No.
	7.10.4 Fault monitoring of automatic fire protection equipment 7.11 Delays to outputs 7.12.2 Dependencies on more than one alarm signal type B (only for FDnet- & MS9i-line Technology) 7.12.3 Dependencies on more than one alarm signal type C 7.13 Alarm counter 8.3 Fault signals from points 8.9 Output to fault warning routing equipment 9.5 Disablement of addressable points 10 Test condition  Notes: 1. Scope of approval does not include the operation of the network functionality. 2. This approval does not constitute compliance with the fire detection and alarm systems requirements of EN 54-13.	
FC722	Control and Indicating Equipment  Incorporating as modular units: FCM2027 PMI- & Mainboard FCM7204-Z3 Operating unit FCM7215-Y3 Operating unit (w/o acces.) SV24V/150W 150W Power supply FCI2002-A1 Periphery board (2-Loop)  and as optional modular units: FCA2001-A1 RS232 Module ( isolated)	126bn/06

This Certificate is maintained and held in force through regular surveillance activities and subject to the corresponding ISO 9001 Certificate being maintained.

  
Signed for BRE Global Ltd

E Mattie-Suleiman  
Verifier

8 March 2019  
Date of Issue

25 May 2016  
Date of First Issue



This certificate and appendix remains the property of BRE Global Ltd. and is issued subject to terms and conditions (for details visit [www.redbooklive.com/terms](http://www.redbooklive.com/terms)).

To check the validity of this certificate and appendix please visit [www.redbooklive.com/check](http://www.redbooklive.com/check), scan the QR tag or contact us.

BRE Global Ltd, Watford, WD25 9XX  
T: +44 (0)333 321 8811 E: [enquiries@breglobal.com](mailto:enquiries@breglobal.com)

LPCB is a Registered Trademark of the Building Research Establishment Ltd.



## Appendix to Certificate No: 126bn

Issue: 05

### Siemens Switzerland Ltd

Certified Product	Description	LPCB Ref.No.
FCA2002-A1	RS485 Module ( isolated)	
FCA2031-A1	Connection Module (MoNet)	
FCI2001-D1	Fire brigade periphery module	
FCI2003-A1	Loop expansion (FDnet)	
FCM7213-Y3	Operating add-on (2xLED indication)	
FCM7214-Y3	Operating add-on (4xLED indication)	
FN2001-A1	Network module (SAFEDLINK) (See note 1)	
FN2008-A1	Ethernet Switch (MM) (see note 1)	
FN2012-A1	Ethernet Switch (modular)	
FP2015-A1	Power Supply 70W	
FTO2001-A1	Event printer set	
FTO2008-A1	LED module	
VN2002-A1	Ethernet module (MM)	
VN2003-A1	Ethernet module (SM)	
FHA2002-A1	Rear wall Standard	
FHA2003-A1	Rear Housing Comfort	
<p>Certified with the following Options with requirements from EN 54-2:</p> <ul style="list-style-type: none"> <li>7.8 Output to fire alarm devices</li> <li>7.9.1 Output to fire alarm routing equipment</li> <li>7.9.2 Alarm Confirmation from fire alarm routing equipment</li> <li>7.10.1 Output to automatic fire protection equipment Type A</li> <li>7.10.2 Output to automatic fire protection equipment Type B</li> <li>7.10.3 Output to automatic fire protection equipment Type C</li> </ul>		

This Certificate is maintained and held in force through regular surveillance activities and subject to the corresponding ISO 9001 Certificate being maintained.



Signed for BRE Global Ltd

E Mattie-Suleiman

Verifier

8 March 2019

Date of Issue

25 May 2016

Date of First Issue



This certificate and appendix remains the property of BRE Global Ltd. and is issued subject to terms and conditions (for details visit [www.redbooklive.com/terms](http://www.redbooklive.com/terms)).

To check the validity of this certificate and appendix please visit [www.redbooklive.com/check](http://www.redbooklive.com/check), scan the QR tag or contact us.

BRE Global Ltd, Watford, WD25 9XX  
T: +44 (0)333 321 8811 E: [enquiries@breglobal.com](mailto:enquiries@breglobal.com)

LPCB is a Registered Trademark of the Building Research Establishment Ltd.



## Appendix to Certificate No: 126bn

Issue: 05

### Siemens Switzerland Ltd

Certified Product	Description	LPCB Ref.No.
	7.10.4 Fault monitoring of automatic fire protection equipment 7.11 Delays to outputs 7.12.2 Dependencies on more than one alarm signal type B (only for FDnet- & MS9i-line Technology) 7.12.3 Dependencies on more than one alarm signal type C 7.13 Alarm counter 8.3 Fault signals from points 8.9 Output to fault warning routing equipment 9.5 Disablement of addressable points 10 Test condition  Notes: 1. Scope of approval does not include the operation of the network functionality. 2. This approval does not constitute compliance with the fire detection and alarm systems requirements of EN 54-13	
FC724	Control and Indicating Equipment  Incorporating as modular units: FCM7204-Z3 Operating unit FCM7215-Y3 Operating unit (w/o acces.) SV24V/150W 150W Power supply FC12004-A1 Periphery board (4-Loop) FCM2027 PMI- & Mainboard  and as optional modular units: FCA2001-A1 RS232 Module ( isolated)	126bn/07

This Certificate is maintained and held in force through regular surveillance activities and subject to the corresponding ISO 9001 Certificate being maintained.

  
Signed for BRE Global Ltd

E Mattie-Suleiman  
Verifier

8 March 2019  
Date of Issue

25 May 2016  
Date of First Issue



This certificate and appendix remains the property of BRE Global Ltd. and is issued subject to terms and conditions (for details visit [www.redbooklive.com/terms](http://www.redbooklive.com/terms)).

To check the validity of this certificate and appendix please visit [www.redbooklive.com/check](http://www.redbooklive.com/check), scan the QR tag or contact us.

BRE Global Ltd, Watford, WD25 9XX  
T: +44 (0)333 321 8811 E: [enquiries@breglobal.com](mailto:enquiries@breglobal.com)

LPCB is a Registered Trademark of the Building Research Establishment Ltd.



## Appendix to Certificate No: 126bn

Issue: 05

### Siemens Switzerland Ltd

Certified Product	Description	LPCB Ref.No.
FCA2002-A1	RS485 Module ( isolated)	
FCA2031-A1	Connection Module (MoNet)	
FCI2001-D1	Fire brigade periphery module	
FCI2003-A1	Loop expansion (Fdnet)	
FCM7213-Y3	Operating add-on (2xLED indication)	
FCM7214-Y3	Operating add-on (4xLED indication)	
FN2001-A1	Network module (SAFEDLINK) (See note 1)	
FN2008-A1	Ethernet Switch (MM) (see note 1)	
FN2012-A1	Ethernet Switch (modular)	
FTO2001-A1	Event printer set	
FTO2008-A1	LED module	
VN2002-A1	Ethernet module (MM)	
VN2003-A1	Ethernet module (SM)	
FHA2003-A1	Rear housing comfort	
<p>Certified with the following Options with requirements from EN 54-2:</p> <ul style="list-style-type: none"> <li>7.8 Output to fire alarm devices</li> <li>7.9.1 Output to fire alarm routing equipment</li> <li>7.9.2 Alarm Confirmation from fire alarm routing equipment</li> <li>7.10.1 Output to automatic fire protection equipment Type A</li> <li>7.10.2 Output to automatic fire protection equipment Type B</li> <li>7.10.3 Output to automatic fire protection equipment Type C</li> <li>7.10.4 Fault monitoring of automatic fire protection equipment</li> <li>7.11 Delays to outputs</li> <li>7.12.2 Dependencies on more than one alarm signal type B (only for FDnet- &amp; MS9i- line Technology)</li> </ul>		

This Certificate is maintained and held in force through regular surveillance activities and subject to the corresponding ISO 9001 Certificate being maintained.



Signed for BRE Global Ltd

E Mattie-Suleiman  
Verifier

8 March 2019  
Date of Issue

25 May 2016  
Date of First Issue



This certificate and appendix remains the property of BRE Global Ltd. and is issued subject to terms and conditions (for details visit [www.redbooklive.com/terms](http://www.redbooklive.com/terms)).

To check the validity of this certificate and appendix please visit [www.redbooklive.com/check](http://www.redbooklive.com/check), scan the QR tag or contact us.

BRE Global Ltd, Watford, WD25 9XX  
T: +44 (0)333 321 8811 E: [enquiries@breglobal.com](mailto:enquiries@breglobal.com)

LPCB is a Registered Trademark of the Building Research Establishment Ltd.



## Appendix to Certificate No: 126bn

Issue: 05

### Siemens Switzerland Ltd

Certified Product	Description	LPCB Ref.No.
	7.12.3 Dependencies on more than one alarm signal type C 7.13 Alarm counter 8.3 Fault signals from points 8.9 Output to fault warning routing equipment 9.5 Disablement of addressable points 10 Test condition  Notes: 1. Scope of approval does not include the operation of the network functionality. 2. This approval does not constitute compliance with the fire detection and alarm systems requirements of EN 54-13.	
FC726	Control and Indicating Equipment  Incorporating as modular units: FCM7204-Z3 Operating unit FCM7215-Y3 Operating unit (w/o acces.) FCA2006-A1 Connection mod. (card cage) SV24V/150W 150W Power supply FCI2004-A1 Periphery board (4-Loop) FCA2008-A1 Card cage (5 slot) FCM2027 PMI- & Mainboard  and as optional modular units: FCA2001-A1 RS232 Module ( isolated) FCA2002-A1 RS485 Module ( isolated)	126bn/08

This Certificate is maintained and held in force through regular surveillance activities and subject to the corresponding ISO 9001 Certificate being maintained.



Signed for BRE Global Ltd

E Mattie-Suleiman  
Verifier

8 March 2019  
Date of Issue

25 May 2016  
Date of First Issue



This certificate and appendix remains the property of BRE Global Ltd. and is issued subject to terms and conditions (for details visit [www.redbooklive.com/terms](http://www.redbooklive.com/terms)).

To check the validity of this certificate and appendix please visit [www.redbooklive.com/check](http://www.redbooklive.com/check), scan the QR tag or contact us.

BRE Global Ltd, Watford, WD25 9XX  
T: +44 (0)333 321 8811 E: [enquiries@breglobal.com](mailto:enquiries@breglobal.com)

LPCB is a Registered Trademark of the Building Research Establishment Ltd.



## Appendix to Certificate No: 126bn

Issue: 05

### Siemens Switzerland Ltd

Certified Product	Description	LPCB Ref.No.
FCA2031-A1	Connection Module (MoNet)	
FCI2001-D1	Fire brigade periphery module	
FCI2003-A1	Loop expansion (FDnet)	
FCI2007-A1	I/O Card RT	
FCI2008-A1	I/O Card (programmable)	
FCI2009-A1	I/O Card Horn	
FCL2001-A1	Line Card (FDnet)	
FCL2002-A1	Line Card (collective)	
FCL2003-A1	Line Card (MS9i)	
FCL2006-A1	Linecard (Interactive)	
FCL2007-A1	Linecard (InteractiveEx)	
FCL7201-Z3	Linecard (SynoLoop)	
FCM7213-Y3	Operating add-on (2xLED indication)	
FCM7214-Y3	Operating add-on (4xLED indication)	
FN2001-A1	Network module (SAFEDLINK) (See note 1)	
FN2008-A1	Ethernet Switch (MM) (see note 1)	
FN2012-A1	Ethernet Switch (MM/SM))	
FTO2001-A1	Event printer set	
FTO2003-D1	LED emergency alarm indicator	
FTO2008-A1	LED module	
VN2002-A1	Ethernet module (MM)	
VN2003-A1	Ethernet module (SM)	
FHA2005-A1	Rear housing large	
Certified with the following Options with requirements from EN 54-2:		

This Certificate is maintained and held in force through regular surveillance activities and subject to the corresponding ISO 9001 Certificate being maintained.

  
Signed for BRE Global Ltd

E Mattie-Suleiman  
Verifier

8 March 2019  
Date of Issue

25 May 2016  
Date of First Issue



This certificate and appendix remains the property of BRE Global Ltd. and is issued subject to terms and conditions (for details visit [www.redbooklive.com/terms](http://www.redbooklive.com/terms)).

To check the validity of this certificate and appendix please visit [www.redbooklive.com/check](http://www.redbooklive.com/check), scan the QR tag or contact us.

BRE Global Ltd, Watford, WD25 9XX  
T: +44 (0)333 321 8811 E: [enquiries@breglobal.com](mailto:enquiries@breglobal.com)

LPCB is a Registered Trademark of the Building Research Establishment Ltd.



**bre**

## Appendix to Certificate No: 126bn

Issue: 05

### Siemens Switzerland Ltd

Certified Product	Description	LPCB Ref.No.
	7.8 Output to fire alarm devices 7.9.1 Output to fire alarm routing equipment 7.9.2 Alarm Confirmation from fire alarm routing equipment 7.10.1 Output to automatic fire protection equipment Type A 7.10.2 Output to automatic fire protection equipment Type B 7.10.3 Output to automatic fire protection equipment Type C 7.10.4 Fault monitoring of automatic fire protection equipment 7.11 Delays to outputs 7.12.1 Dependencies on more than one alarm signal A ( only for MS9i-, collective-, SynoLoop-, Interactive - & InteractiveEx- line Technology) 7.12.2 Dependencies on more than one alarm signal type B 7.12.3 Dependencies on more than one alarm signal type C 7.13 Alarm counter 8.3 Fault signals from points 8.9 Output to fault warning routing equipment 9.5 Disablement of addressable points 10 Test condition Notes: 1. Scope of approval does not include the operation of the network functionality. 2. This approval does not constitute compliance with the fire detection and alarm systems requirements of EN 54-13	
FC723	Control and Indicating Equipment  Incorporating as modular units:	126bn/09

This Certificate is maintained and held in force through regular surveillance activities and subject to the corresponding ISO 9001 Certificate being maintained.

  
Signed for BRE Global Ltd

E Mattie-Suleiman  
Verifier

8 March 2019  
Date of Issue

25 May 2016  
Date of First Issue



This certificate and appendix remains the property of BRE Global Ltd. and is issued subject to terms and conditions (for details visit [www.redbooklive.com/terms](http://www.redbooklive.com/terms)).

To check the validity of this certificate and appendix please visit [www.redbooklive.com/check](http://www.redbooklive.com/check), scan the QR tag or contact us.

BRE Global Ltd, Watford, WD25 9XX  
T: +44 (0)333 321 8811 E: [enquiries@breglobal.com](mailto:enquiries@breglobal.com)

LPCB is a Registered Trademark of the Building Research Establishment Ltd.



## Appendix to Certificate No: 126bn

Issue: 05

### Siemens Switzerland Ltd

Certified Product	Description	LPCB Ref.No.
FCM7204-Z3	Operating unit	
FCM7215-Y3	Operating unit (w/o acces.)	
FCA2006-A1	Connection mod. (card cage)	
FCA2007-A1	Card cage (2slot)	
SV24V/150W	150W Power supply	
FCI2002-A1	Periphery board (2-Loop)	
FCM2027	PMI- & Mainboard	
and as optional modular units:		
FCA2001-A1	RS232 Module ( isolated)	
FCA2002-A1	RS485 Module ( isolated)	
FCA2031-A1	Connection Module (MoNet)	
FCI2001-D1	Fire brigade periphery module	
FCI2003	Loop expansion (Fdnet)	
FCI2007-A1	I/O Card RT	
FCI2008-A1	I/O Card (programmable)	
FCI2009-A1	I/O Card Horn	
FCL2001-A1	Line Card (Fdnet)	
FCL2002-A1	Line Card (collective)	
FCL2003-A1	Line Card (MS9i)	
FCL2006-A1	Linecard (Interactive)	
FCL2007-A1	Linecard (InteractiveEx)	
FCL7201-Z3	Linecard (SynoLoop)	
FCM7204-Z3	Control unit	
FCM7213-Y3	Operating add-on (2xLED indication)	

This Certificate is maintained and held in force through regular surveillance activities and subject to the corresponding ISO 9001 Certificate being maintained.

  
Signed for BRE Global Ltd

E Mattie-Suleiman  
Verifier

8 March 2019  
Date of Issue

25 May 2016  
Date of First Issue



This certificate and appendix remains the property of BRE Global Ltd. and is issued subject to terms and conditions (for details visit [www.redbooklive.com/terms](http://www.redbooklive.com/terms)).

To check the validity of this certificate and appendix please visit [www.redbooklive.com/check](http://www.redbooklive.com/check), scan the QR tag or contact us.

BRE Global Ltd, Watford, WD25 9XX  
T: +44 (0)333 321 8811 E: [enquiries@breglobal.com](mailto:enquiries@breglobal.com)

LPCB is a Registered Trademark of the Building Research Establishment Ltd.



## Appendix to Certificate No: 126bn

Issue: 05

### Siemens Switzerland Ltd

Certified Product	Description	LPCB Ref.No.
	FCM7214-Y3 Operating add-on (4xLED indication)	
	FN2001-A1 Network module (SAFEDLINK) (See note 1)	
	FN2008-A1 Ethernet Switch (MM) (see note 1)	
	FN2012-A1 Ethernet Switch (modular)	
	FTO2001-A1 Event printer set	
	FTO2008-A1 LED module	
	VN2002-A1 Ethernet module (MM)	
	VN2003-A1 Ethernet module (SM)	
	FHA2003-A1 Rear housing comfort	
	<p>Certified with the following Options with requirements from EN 54-2:</p> <ul style="list-style-type: none"> <li>7.8 Output to fire alarm devices</li> <li>7.9.1 Output to fire alarm routing equipment</li> <li>7.9.2 Alarm Confirmation from fire alarm routing equipment</li> <li>7.10.1 Output to automatic fire protection equipment Type A</li> <li>7.10.2 Output to automatic fire protection equipment Type B</li> <li>7.10.3 Output to automatic fire protection equipment Type C</li> <li>7.10.4 Fault monitoring of automatic fire protection Equipment</li> <li>7.11 Delays to outputs</li> <li>7.12.1 Dependencies on more than one alarm signal type A (only for MS9i-, collective-, SynoLoop-, Interactive - &amp; InteractiveEx- line Technology )</li> <li>7.12.2 Dependencies on more than one alarm signal type B</li> <li>7.12.3 Dependencies on more than one alarm signal type C</li> <li>7.13 Alarm counter</li> <li>8.3 Fault signals from points</li> <li>8.9 Output to fault warning routing equipment</li> </ul>	

This Certificate is maintained and held in force through regular surveillance activities and subject to the corresponding ISO 9001 Certificate being maintained.



Signed for BRE Global Ltd

E Mattie-Suleiman

Verifier

8 March 2019

Date of Issue

25 May 2016

Date of First Issue



This certificate and appendix remains the property of BRE Global Ltd. and is issued subject to terms and conditions (for details visit [www.redbooklive.com/terms](http://www.redbooklive.com/terms)).

To check the validity of this certificate and appendix please visit [www.redbooklive.com/check](http://www.redbooklive.com/check), scan the QR tag or contact us.

BRE Global Ltd, Watford, WD25 9XX  
T: +44 (0)333 321 8811 E: [enquiries@breglobal.com](mailto:enquiries@breglobal.com)

LPCB is a Registered Trademark of the Building Research Establishment Ltd.



## Appendix to Certificate No: 126bn

Issue: 05

### Siemens Switzerland Ltd

Certified Product	Description	LPCB Ref.No.
	9.5 Disablement of addressable points 10 Test condition  Note: 1.Scope of approval does not include the operation of the network functionality. 2. This approval does not constitute compliance with the fire detection and alarm systems requirements of EN 54-13.	
FT2040	Fire detection terminal for use with FC2020, FC2030, FC2040 & FC2060 Control and Indicating Equipment  Incorporating as modular units: FCM2027 PMI- & Mainboard FCM2028-A2 Operating unit FCM2037-A2 Operating unit (w/o accs.) FTI2001-A1 Fire terminal board FP2015-A1 Power Supply 70W  and as optional modular units: FCA2001-A1 RS232 Module ( isolated) FCA2002 -A1 RS485 Module ( isolated) FCA2031-A1 Connection Module (MoNet) FCM2036-A2 Operating add-on (4xLED indication) FCM2038-A2 Operating add-on (2xLED indication) FN2001-A1 Network module (SAFEDLINK) (See note 1) FN2008-A1 Ethernet Switch (MM) (see note 1) FN2012-A1 Ethernet Switch (MM/SM)	126bn/R01

This Certificate is maintained and held in force through regular surveillance activities and subject to the corresponding ISO 9001 Certificate being maintained.



Signed for BRE Global Ltd

E Mattie-Suleiman

Verifier

8 March 2019

Date of Issue

25 May 2016

Date of First Issue



This certificate and appendix remains the property of BRE Global Ltd. and is issued subject to terms and conditions (for details visit [www.redbooklive.com/terms](http://www.redbooklive.com/terms)).

To check the validity of this certificate and appendix please visit [www.redbooklive.com/check](http://www.redbooklive.com/check), scan the QR tag or contact us.

BRE Global Ltd, Watford, WD25 9XX  
 T: +44 (0)333 321 8811 E: [enquiries@breglobal.com](mailto:enquiries@breglobal.com)

LPCB is a Registered Trademark of the Building Research Establishment Ltd.



## Appendix to Certificate No: 126bn

Issue: 05

### Siemens Switzerland Ltd

Certified Product	Description	LPCB Ref.No.
	FTO2001-A1 Event printer set FTO2008-A1 LED module VN2002-A1 Ethernet module (MM) VN2003-A1 Ethernet module (SM) FHA2001-A1 Rear housing (Eco) H28G200 Housing base  Notes: 1. Scope of approval does not include the operation of the network functionality. 2. This approval does not constitute compliance with the fire detection and alarm systems requirements of EN 54-13	
FT724	Fire detection terminal for use with FC721, FC722, FC723, FC724 & FC726 Control and Indicating Equipment  Incorporating as modular units: FCM7204-Z3 Operating unit FCM7215-Y3 Operating unit (w/o acces.) FTI2001-A1 Fire terminal board FP2015-A1 Power Supply 70W FCM2027 PMI- & Mainboard  and as optional modular units: FCA2001-A1 RS232 Module (isolated) FCA2002-A1 RS485 Module (isolated) FCA2031-A1 Connection Module (MoNet)	126bn/R02

This Certificate is maintained and held in force through regular surveillance activities and subject to the corresponding ISO 9001 Certificate being maintained.

  
Signed for BRE Global Ltd

E Mattie-Suleiman  
Verifier

8 March 2019  
Date of Issue

25 May 2016  
Date of First Issue



This certificate and appendix remains the property of BRE Global Ltd. and is issued subject to terms and conditions (for details visit [www.redbooklive.com/terms](http://www.redbooklive.com/terms)).

To check the validity of this certificate and appendix please visit [www.redbooklive.com/check](http://www.redbooklive.com/check), scan the QR tag or contact us.

BRE Global Ltd, Watford, WD25 9XX  
T: +44 (0)333 321 8811 E: [enquiries@breglobal.com](mailto:enquiries@breglobal.com)

LPCB is a Registered Trademark of the Building Research Establishment Ltd.



## Appendix to Certificate No: 126bn

Issue: 05

### Siemens Switzerland Ltd

Certified Product	Description	LPCB Ref.No.
FCM7213-Y3	Operating add-on (2xLED indication)	
FCM7214-Y3	Operating add-on (4xLED indication)	
FN2001-A1	Network module (SAFEDLINK) (See note 1)	
FN2008-A1	Ethernet Switch (MM) (see note 1)	
FN2012-A1	Ethernet Switch (MM/SM)	
FTO2001-A1	Event printer set	
FTO2008-A1	LED module	
VN2002-A1	Ethernet module (MM)	
VN2003-A1	Ethernet module (SM)	
FHA2001-A1	Rear housing (Eco)	
H28G200	Metal Housing	
<p>Notes:</p> <ol style="list-style-type: none"> <li>1. Scope of approval does not include the operation of the network functionality.</li> <li>2. This approval does not constitute compliance with the fire detection and alarm systems requirements of EN 54-13.</li> </ol>		

This Certificate is maintained and held in force through regular surveillance activities and subject to the corresponding ISO 9001 Certificate being maintained.



Signed for BRE Global Ltd

E Mattie-Suleiman

Verifier

8 March 2019

Date of Issue

25 May 2016

Date of First Issue



This certificate and appendix remains the property of BRE Global Ltd. and is issued subject to terms and conditions (for details visit [www.redbooklive.com/terms](http://www.redbooklive.com/terms)).

To check the validity of this certificate and appendix please visit [www.redbooklive.com/check](http://www.redbooklive.com/check), scan the QR tag or contact us.

BRE Global Ltd, Watford, WD25 9XX  
T: +44 (0)333 321 8811 E: [enquiries@breglobal.com](mailto:enquiries@breglobal.com)

LPCB is a Registered Trademark of the Building Research Establishment Ltd.





**To Whom It May Concern**

Name	Calvin Yeung
Division	Smart Infrastructure
Department	Sales
Telephone	(852) 6312 5070
Fax	(852) 2407 4457
Mobile	(852) 6312 5070
E-mail	calvin.yeung@siemens.com
Internet	<a href="http://www.siemens.com.hk">www.siemens.com.hk</a>
Your letter of	
Our reference	MF/COO/CP
Date	10 Dec 2025

Dear Sir / Madam,

**Re: Country of Origin for “Siemens” Cerberus Pro Automatic Fire Alarm System**

<b>Model No.</b>	<b>Description</b>	<b>Country of Origin</b>
FC726	Addressable Fire Alarm Panel	Switzerland
FC724	Addressable Fire Alarm Panel	Switzerland
FC723	Addressable Fire Alarm Panel	Switzerland
FC722	Addressable Fire Alarm Panel	Switzerland
FC721	Addressable Fire Alarm Panel	Switzerland
FT724	Repeater Panel	Switzerland
OP720	Smoke Detector	China
HI720	Heat Detector	China
HI722	Heat Detector	China
OH720	Multi-Sensor Smoke Detector	China
OOHC740 / OOH740	Multi-Sensor Smoke Detector	Switzerland
OOH740-A9-EX	Explosion Proof Smoke / Heat Detector	Switzerland
FDB201	Detector Base	Switzerland
DB721 / DB722	Detector Base	China
FDM221 / FDM231-RP	Manual Call Point	China
FDM225-RP	Manual Call Point	Great Britain
FDM225-RG	Manual Call Point	Great Britain
FDMH295-R	Back Box for MCP	China
FDM226-RP	Manual Call Point Weatherproof	Great Britain
FDM226-RG	Manual Call Point Weatherproof	Great Britain
FDCIO221	Input/ Output Module	China
FDCI221	Input Module	China
FDCI222	Input Module	China
FDCIO222	Input/ Output Module	China
FDCIO223	Input Module for Special Detector(s)	China
FDCH221	Housing for Module	China
FC121-ZA	Conventional Fire Control Panel	China
DCA1192A	Line Coupler	Switzerland
DCB1192A	Terminal Plate	China
FDBH291	Anti-Condensation Heater	China
FDB295	Wet Base	China
DCA1191	Housing	China
STAHL / 9001-00-280-100-101	Safety Barrier	Slovakia
DBS720 / FDSB226	Sounder Base	China
FT2011-A1 / FT2010-A1	Floor Repeater	Switzerland

FDL242	Linear Smoke Detector / Beam Detector	Great Britain
FDLR242	Reflective Prism	Great Britain
FDLRLA242	Reflector for long / short distance	Great Britain
FDF242 / FDF242-EX	Flame Detector	Norway
FDA241	Air Sampling Smoke Detector	Switzerland
FDA261	Air Sampling Smoke Detector	Switzerland
FDCC221S	Communication Interface for FDA241	Switzerland

Should you have any query, please do not hesitate to contact the undersigned at (852) 6312 5070.

Thank you for your kind attention.

Yours faithfully,  
Siemens Limited

Calvin Yeung

Digitally signed by  
Yeung Wing Fai   
DN: cn=Yeung Wing  
Fai, o=DF

Assistant Sales Manager



**To Whom It May Concern**

Name	Nelson Chow
Division	Smart Infrastructure - Buildings
Department	Sales
Telephone	(852) 9721 6830
Fax	(852) 2407 4457
Mobile	(852) 9721 6830
E-mail	<a href="mailto:nelson.chow@siemens.com">nelson.chow@siemens.com</a>
Internet	<a href="http://www.siemens.com.hk">www.siemens.com.hk</a>
Your letter of	
Our reference	MF0933/07/NC
Date	15 Dec 2025

Dear Sir / Madam,

**Re: Compatible letter for “Siemens” Automatic Fire Alarm System**

We write to confirm that “Siemens” FC726 / FC724 / FC723 / FC722 / FC721 Fire Alarm Panel is compatible with OP720, Smoke Detector, OOH740 / OOHC740 Multi-sensor smoke detector, HI720 / HI722 Heat Detector, DBS720 / FDSB226 Sounder Base, FDM231/ FDM225-RP / FDM226-RP Manual Call Point, FDCI221, FDCI222 Input Module, FDCIO221, FDCIO222 Input/ Output Module, FDCIO223 Input Module for Ex-application, OOH740-A9-Ex explosion proof smoke/ heat detector, STAHL 9001/00-280-100-101 safety barrier, FC121-ZA conventional Panel and FT2011-A1 / FT2010-A1 & FT724 repeater.

Should you have any query, please do not hesitate to contact the undersigned at (852) 9721 6830.

Thank you for your kind attention.

Yours faithfully,  
Siemens Limited

 Digitally signed by  
Chow Siu Wah  
Location: Hong  
Kong (RC-HK SI  
B) by Nelson  
Chow

Nelson Chow  
Head of V&E Customers Sales  
Smart Infrastructure - Buildings

# SIEMENS

## SIEMENS 'SINTESO / CERBERUS PRO' Addressable AFA System

FC2020/ FC2020-AA/ FC2020-AE/ FC2020-AZ/ FC2020-EZ; FC2030/ FC2030-AA;  
FC2040/FC2040-AA/FC2040-AG; FC2060 / FC2060-AA; FC2080; FC721/FC721-ZZ/ FC721-ZA;  
FC722 / FC722-ZZ/ FC722-ZA; FC723/ FC723-ZA; FC724/ FC724-ZZ/ FC724-ZA; FC726/  
FC726-ZA FS 20 Series Main Fire Alarm Panel  
FT2040 / FT724 / FT2011-A1/ FT2010-A1 Repeater Panel  
FT2001-A1 Mimic Display Driver  
FDOOTC241/ FDOOT241-A/ FDOOT221 / OH720 / OOH740 / OOHC740 Multi-sensor  
Detector  
OP720 / FDO221/ FDO241 Smoke Detector/ FDT221/ FDT241 / H1720 / H1722 Heat  
Detector  
FDB222/ DB721/ DB722 Detector Base/ FDSB291 / DBS720 / FDSB226 Sounder Base  
FDM231 / FDM221 / FDM225-RG & FDM225-RP (Indoor)/ FDM226-RG & FDM226-RP  
(Outdoor) Manual Call Point & FDMH295-R Back Box for MCP  
FDCIO221/ FDCI221 / FDCI222/ FDCIO222/ FDCIO223 Input & Output Module

### MAJOR JOB REFERENCE (Hong Kong)

Project (Hong Kong)	Client	Date Commenced
Tamar Government Headquarter	Architectural Services Department	02/2008
Tuen Mun Riding School	Hong Kong Jockey Club	03/2008
Toy Story, Hong Kong Disneyland	Hong Kong Government/ Walt Disney	05/2008
Fortune Terrace	Hongfaith Engineering Ltd	06/2008
River Beas Club House	Hong Kong Jockey Club	10/2008
Shatin Racecourse	Hong Kong Jockey Club	10/2008
HAPPY VALLEY RACECOURSE (HVRC) – INFIELD (including Large Video Screen and Indicators)	Hong Kong Jockey Club	10/ 2008
Lai See Industrial Building	Fook Cheong Engineering (HK) Ltd.	03/2009
Temple at Tuen Mun	Kin Ying Contracting Company	03/2009
Aberdeen Ball Club	Aberdeen Ball Club	03/2009

# SIEMENS

YoHo Midtown	Sun Hung Kai Properties Ltd.	03/2009
No.32 Chung Hom Kok	Hongfaith Engineering Ltd.'	04/2009
Siu Sai Wan Complex	Architectural Services Department	04/2009
Church at No 18 Cornwall Street	Hongfaith Engineering Ltd	06/2009
East Ocean Centre	Hongfaith Engineering Ltd	06/2009
LaSalle College	LaSalle College	07/2009
235-245 Queen's Road East (Open Kitchen)	Nan Fung Development	07/2009
Mytics, Hong Kong Disneyland	Hong Kong Government/ Walt Disney	08/2009
St. Paul Hospital	St. Paul Hospital	09/2009
Hong Kong Exhibition and Convention Centre	Hong Kong Trade Development Council	10/2009
863-865 King's Road	Kerry Properties Ltd	10/ 2009
Proposed Hotel Development 119-120 Connaught Road, Central	Kin Ying Engineering Ltd	10/ 2009
No. 6 Siu Fai Terrace	Hongfaith Engineering Ltd	10/ 2009
Kee Wah Factory	Kee Wah Group	12/2009
Adventist Hospital, Hong Kong	Adventist Hospital	01/2010
3-5 Star Street	Swire Properties	02/2010
Tong Yan Sun Tsuen	New World Group	02/2010
Primary School at Shek Kip Mei Phase 4	Architectural Services Department	04/2010
Sports Centre in Area 28A Fanling Sheung Shui (SST301)	Architectural Services Department	04/2010
KL 11146 Hoi Fai Road, Kowloon	Sun Hung Kai Properties Ltd.	05/2010
77-85 Bedford Road	Ka Wah International	05/2010
No 24-32 Ming Yuen Western Road	Kowloon Development Co., Ltd.	06/2010
1-3 Victory Avenue. Ho Man Tin	Ka Wah International	06/2010
Substation 207, Infrastructure Expansion,	Hong Kong Government/ Walt Disney	06/2010

# SIEMENS

Parkwide, Hong Kong Disneyland

St. Francis Canossian School	St. Francis' Canossian School	06/2010
Park at Tin Shui Wai	Architectural Services Department	06/2010
Tsui Wah Building at No. 51, Lai Yip Street, Kwun Tong	Tsui Wah Restaurant	06/2010
City Hall, Central	Architectural Services Department	06/2010
Li Po Chun United world College	Li Po Chun United World College	06/2010
102F T1 International Trade Centre	Sun Hung Kai Properties Ltd.	07/2010
Li Shu Fan Phase I, The University of Hong Kong	The University of Hong Kong	08/2010
Latitude, San Po Kong	Sun Hung Kai Properties Ltd.	08/2010
Kennedy Town Swimming Pool Phase I	MTRC / Architectural Services Department	09/2010
Infrastructure Expansion, Building 638, Substation 208, Hong Kong Disneyland	Hong Kong Government / Walt Disney	09/2010
Club Siena, Discovery Bay	Hong Kong Resort Company Ltd.	09/2010
Proposed Hotel Development at 2 & 4 Hau Wo Street, Kennedy Town	Kin Ying Contracting Ltd.	10/2010
Proposed Industrial Building at Lop Yip Street & Yip Cheong Street, Fanling	Kin Ying Contracting Ltd.	10/2010
Warehouse, Hong Kong Disneyland	Hong Kong Government/ Walt Disney	10/2010
Nurse Quarters, St Teresa Hospital 20& 22 Lonmond Road	St. Teresa Hospital	10/2010
West Island Line- Reprovision of David Trench Rehabilitation Centre	MTRC/ Architectural Services Department	10/2010
Grizzly Gulch, Hong Kong Disneyland	Hong Kong Government / Walt Disney	11/2010
HKCCCU Logos Academy Extension, TKO	HKCCCU Logos Academy	11/2010
VTC, 145 Pokfulam	Vocational Training Centre	11/2010

# SIEMENS

1111 Wuhu Street, Hunghom / Wuhu Residence (Open Kitchen)	Chong's Properties	11/2010
Centennial Campus Phase 1, The University of Hong Kong	The University of Hong Kong	01/2011
Mongkok Dental Clinic	Architectural Services Department	01/2011
Custom & Excise Department Married Staff Quarters at 9-11 Tsing Chau Street	Architectural Services Department	01/2011
International School at Discovery Bay	Shun Hing Contracting Ltd	04/2011
18-36 Shing On Street (Open Kitchen)	Emperor Properties	04/2011
Ma Wan Rural Committee Office	Ma Wan Rural Committee	05/2011
PLK Centenary Li Shiu Chung Memorial College, Tai Hing Estate Tuen Mun	Architectural Services Department	05/2011
PLK Tang Yuk Tien College, Wu King Estate, Tuen Mun	Architectural Services Department	05/2011
Food Inspection Centre, Man Kam Road	Architectural Services Department	05/ 2011
Sunshine City, Ma On Shan	Henderson Real Estate Agency	06/2011
King Ying Street, Kwun Tong	Henderson Real Estate Agency	08/2011
Nin Jiom Medicine Manufacturing Plant	Nin Jiom Medicine	08/2011
Pharmacy Workshop 46 Wang Lee Street, Yuen Long	Private Pharmacy Company	09/2011
1800 Student Hostel, The University of Hong Kong	The University of Hong Kong	10/ 2011
Kowloon City SPSI & 2	Drainage Services Department	10/2011
Yuen Fat Godown	Yuen Fat Fodown	10/2011
Sunshine City Plaza, Ma On Shan	Henderson Real Estate Agency Ltd.	10/2011
No. 21 Tai Tam Road	Liaison Office of the Central	11/2011

	Peoples Government in H.K. SAR	
Residential Development Fuk Wing Street	Chinachem Group	12/2011
CIC-Zero Carbon Building	Hong Kong SAR Government	12/2011
Central Reclamation Phase II	Architectural Services Department	01/2012
Happy Valley Racecourse – Public Stand	The Hong Kong Jockey Club	01/2012
Castle Peak Hospital	Architectural Services Department	02/2012
Ma Wan Hostel	Sun Hung Kai Properties Ltd	02/2012
TKOTL 76 Area 66B	Sun Hung Kai Properties Ltd	04/2012
771B Kennedy Town Station, West Island Line	MTRC	05/2012
Central Wanchai Bypass at Wanchai East	Highway Department	06/2012
Tsing Lung Tao	Sun Hung Kai Properties Ltd	06/2012
Queen Mary Hospital Nurse Quarters	EMSD	06/2012
Prince of Wales Hospital Main Block	EMSD	06/2012
The Peninsula Hotel	The Peninsula Hong Kong	01/2013
The construction of Sports Centre, Community Hall and District Library in Area 148 Shatin	Architectural Services Department	02/2013
11 Jones Street & 11 Warren Street, Tai Hang	Wing Tai Asia	02/2013
New Factory of Maxim's on No 5 Dai Shun Factory Tai Po	Maxim's	02/2013
Engineer's Site Accommodation Po Kong Village Road	Architectural Services Department	02/2013
University Street (Phase 3)	The University of Hong Kong	02/2013
Regal Riverside Hotel	Regal Hotel	03/2013
Tsing Fung Street Hotel	King Ying Contracting Ltd	03/2013



Chow Yei Ching Building	The University of Hong Kong	04/2013
Central Police Station Conservation & Revitalization	Hong Kong Jockey Club	05/2013
Hotel, Queen's Road Central	Sino Properties	07/2013
Hotel, 6 Krusford Terrace	Henderson Land Development Ltd	08/2013
Bright Future Pharmacy Plant, Yuen Long	Bright Future Pharmacy	09/2013
75-81 Sa Po Road	Chinachem Properties	10/2013
110A-110B Argyle Street	Kerry Properties	11/2013
Communication & Technologies Centre, Shatin	Hong Kong Jockey Club	11/2013
Butterfly Hotel, TST	Butterfly Hotel Group	11/2013
Un Chau Street	Chinachem Properties	11/2013
Cheung Sha Residential Bldg	Sino Properties	11/2013
Tin Shui Wai Temp Site Office	Sky Eng	11/2013
3-5 Ede Road	Chinachem Properties	12/2013
TKOTL 76 Area 66C1	Sun Hung Kai Properties	12/2013
Shatin 14B Sport Center	Architectural Services Department	12/2013
TKOL TL39 and Extension	Hongfaith Engineering	01/2014
18-32 Junction Road	Shun Cheong Electrical	01/2014
Block B, St. Paul's Hospital	St. Paul's Hospital	01/2014
Pauline Chan Building	The University of Hong Kong	01/2014
Dept. of Justice Relocation	Architectural Services Department	02/2014
Deep Water Road	Sun Hung Kai Properties	02/2014
New Koala Attraction, Ocean Park	Ocean Park Corporation	03/2014
New Ambulance Depot, Sheung Shui	Architectural Services Department	02/2014
6 Krusford Terrace Hotel	Henderson Land Development	04/2014

# SIEMENS

Area 66C1, TKO	Sun Hung Kai Properties Ltd	04/2014
Deep Water Bay Road	Sun Hung Kai Properties Ltd	04/2014
Postgraduate Residence/ Hostel	The University of Hong Kong	05/2014
39-43 Nga Tsin Wai Road	Suen Tat Metal Machine Factory	05/2014
TDS, Disneyland	Hong Kong Government / Walt Disney	06/2014
MTRC1126, Wan Chai Sport Complex	MTRC/ Architectural Services Department	06/2014
Langham Hotel, TST	Langham Hotel	07/2014
21-27A Chatham Road, TST	Joinwell Technical	08/2014
Lot 52, Shatin	Architectural Services Department	10/2014
Castle Peak Hospital	Architectural Services Department	10/2014
Kwong Wah Hospital	Architectural Services Department	10/2014
Patrick Mansion Building (North Wing)	The University of Hong Kong	10/2014
74 Queen's Road Central Hotel	Sino Group	11/2014
Chung On Street, Tsuen Wan	Li's Fire	11/2014
91-103 Parkes Street	Chuang's Consortium Int.	11/2014
42 Wang Lee Street	Productive	11/2014
Maxim's Factory at Tai Po	Maxim's	12/2014
Belvedere Garden Shopping Centre	Belvedere Garden	12/2014
Proposed Hotel at 89-100 Tung Lo Wan Rd	Better Chance International Ltd.	12/2014
Lei Garden Food Factory	Lei Garden Restaurant Group	12/2014
Harbour Road Sports Centre	Leisure & Cultural Services Department	12/2014
TKO Area 66C1 Residential Development	Sun Hung Kai Properties Ltd/ MTRC	01/2015
Heng Seng School of Commerce	Heng Seng School of Commerce	03/2015
Conversion of Senior Staff Quarter at	Architectural Services Department	03/2015

# SIEMENS

Mary Hospital

DD331 Cheung Sha	Swire Properties	04/2015
Langham Hotel, TST	Langham Hotel	04/2015
Iron Man Experience, Hong Kong Disneyland	Hong Kong Government/ Walt Disney	06/2015
Heng Sang Bank at Mongkok	Heng Sang Bank	06/2015
Gleneagles HK Hospital	GHK/ New World Development	05/2015
Arts Pavilion, West Kowloon Cultural District	West Kowloon Cultural District	06/2015
MTRC Contract 1123, EXH & Wan Chai Sport Complex	MTRC / Architectural Services Department	06/2015
M+ Museum Mock Up, West Kowloon Cultural District	West Kowloon Cultural District	07/2015
Heng Seng Bank, Arygle Street, Mongkok	Heng Seng Bank	08/2015
Kennedy Town Swimming Pool Phase 2	MTRC / Architectural Services Department	09/2015
18 Pik Sha Street	Chinachem Group	09/2015
TW5 City Side Residential Development	Chinachem Group/ MTRC	12/2015
TW5 Bay Side Residential Development Phase 1	Cheung Kong Holdings Ltd/ MTRC	04/2016
Tak Yip Street, Yuen Long	Sun Hung Kai Properties Ltd	04/2016
Shek Lei Shopping Centre	Housing Authority / The Link	04/2016
Siu Lik Yuen Hotel	Sun Hung Kai Properties Ltd	05/2016
TW5 Bay Side Residential Development Phase 2	Cheung Kong Holdings Ltd/ MTRC	06/2016
35 Baker Road, Peak	Henderson Land	07/2016
Town Lot No.70 Area 86, Site D LOHAS Park, Package 4	Sun Hung Kai Properties Ltd/ MTRC	09/2016
18 & 20 Caine Road	Sun Hung Kai Properties Ltd	10/2016
Caritas Social Centre at	The Catholic Diocese of Hong Kong	10/2016

9 Sheng Mun Road, Tsuen Wan

Hong Kong-Zhuhai-Macao Bridge Hong Kong Link Road Section Between HKSAR Boundary & Scenic Hill	Hong Kong Government	10/2016
The Fleming Hotel Renovation	The Fleming Hotel	11/2016
Proposed Hotel at 33-49, Des Voeux Road	Nan Fung Group	11/2016
Global Switch Data Centre at Tseung Kwan O Industrial Estate Phase 1	Global Switch Hong Kong Limited	11/2016
Wong's Industrial Centre at 180 Wai Yip Street, Kwun Tong	Wong's International Holdings Ltd.	12/2016
House 18, Bisney Crest, 55-57 Bisney Road	Chinachem Group	12/2016
Island Residence 163 Shaukeiwan Road	Wheelock Properties (Hong Kong) Ltd.	12/2016
Haking Wong Building	The University of Hong Kong	12/2016
Proposed Residential Building 565 Kau To Shan	Eco-Green Group Limited	01/2017
Proposed Residential Building 163 Kau To Shan	Eco-Green Group Limited	02/2017
Kwai Chung Hospital Block LM	EMSD	04/2017
MTRC1126 Wan Chai Swimming Pool	MTRC / Architectural Services Department	04/2017
HK-Zhuhai-Macau Bridge Hong Kong Link Road Section Between Scenic Hill and Hong Kong Boundary Crossing Facilities	Hong Kong Government	05/2017
Xiqu Centre	West Kowloon Cultural District	05/2017
17-19 Yik Yam St. Happy Valley	Emperor International Holdings Ltd	06/2017
310 Prince Edward Road West/ Gallant Villa	United Properties Ltd.	06/2017
HK-Zhuhai-Macau Bridge Hong Kong Link Road / PCB	Highways Department	06/2017

# SIEMENS

Imperial Cullinan Upgrade	Sun Hung Kai Properties Ltd.	07/2017
8-10 Wong Chuk Hang Road	Swire Properties	07/2017
Lin Fa Kung Street (Site C)	Better Chance International	07/2017
Lin Fa Kung Street (Site D)	Better Chance International	07/2017
Hong Chi Phase 2	Hong Chi Association	09/2017
The West Wing of Central Government Office	Architectural Services Department	10/2017
Butterfly Hotel at Austin Road	Butterfly Hotel	11/2017
Coach Parking for Ocean Park	Ocean Park Corporate	11/2017
68-86 Wang Fung Street	Far East Properties	12/2017
Siu Lik Yuen Hotel	Sun Hung Kai Properties	12/2017
West Kowloon Government Office at Yau Ma Tei	Architectural Services Department	01/2018
TKOTL70 Area 86, Site N, LOHAS Park, Package 6	Nan Fung Group/ MTRC	01/2018
FSSTL225, J/O Luen Hing Street, Fanling	Henderson Land	01/2018
Hong Kong Sanatorium Hospital (Happy Valley)	HK Sanatorium Hospital	03/2018
Global Switch Data Centre at Tseung Kwan O Industrial Estate Phase 2	Global Switch Hong Kong Ltd.	04/2018
TMTL 500 Kwun Chiu Road, Tuen Mun	Evergrande Real Estate	06/2018
OT Block Expansion, Tuen Mun Hospital	Hong Kong Hospital Authority	06/2018
Eastern Medical Centre at 5AKN	Hong Kong Sanatorium Hospital	07/2018
Kings Wing Plaza	Billion Development and Project Management Ltd	07/2018
Primary School at Anderson Road, Kwun Tong	Architectural Services Department	09/2018
6-22 Chung Ching Street	Henderson Land Group	10/2018
Stubb Road	Sun Hung Kai Properties Ltd	12/2018

HK Airport Contract 3712 – New Project Site Office	The Airport Authority Hong Kong	12/2018
KGO Pumpcell at West Kowloon Cultural Centre	West Kowloon Cultural District Authority	12/2018
EP, Panda Café & AAA, Ocean Park	Ocean Park Corporation	12/2018
Hing Hon Road	Kerry Properties Limited	01/2019
A New Club House at Shan Kwong Road	Hong Kong Jockey Club	01/2019
Ki Lung Street	Henderson Land	01/2019
Lai King Workshop	Architectural Services Department	01/2019
Chun Yip Street Market	Architectural Services Department	01/2019
1-11 Kwai Hei Street	Henderson Land	02/2019
411 Catham Road North	Henderson Land	02/2019
A Boy School in Area 28 Tuen Mun	Architectural Services Department	03/2019
No. 106 Yip Wong Road Tuen Mun Lot. No. 514	Henderson Land Development Company Limited	03/2019
The Arch, Kowloon Station	Sun Hung Kai Properties Ltd	03/2019
Residential Dev. TKOTL70 Site	Cheung Kong (Holdings) Limited/ MTRC	03/2019
180-184 Shau Kei Wan Road	EASE Day Limited	04/2019
Vehicle Exam Centre Tsing Yi	Transport Department	04/2019
Tai Wai Station STTL No.52	New World Development Co Ltd/ MTRC	04/2019
STTL601 Yiu Sha Rd, Ma On Shan	Country Garden (Hong Kong) Ltd	05/2019
Tuen Mun Hospital New OT Bk Extension	Hong Kong Hospital Authority	06/2019
Medical Complex Extension	The University of Hong Kong	06/2019
Shek Wu Hui Sewage Treatment Work	Drainage Services Department, HKSAR	07/2019
68-70 Electric Road	Success Seeker Limited	07/2019

# SIEMENS

Ocean Park Waterfront	Ocean Park Corporation	07/2019
Eastern Medical Centre at 3AKN	Hong Kong Sanatorium Hospital	07/2019
Castle, Hong Kong Disneyland	Hong Kong International Theme Parks Ltd	08/2019
Grandstand South & Training Pool, South China Athletic Association	South China Athletic Association	08/2019
Fu Shan Public Mortuary	Architectural Services Department	08/2019
TMTL500, Kwun Chiu Road, Tuen Mun	China Evergrande Group	08/2019
Global Switch HK1 Building 4 & 5	Global Switch Hong Kong Limited	09/2019
Win Plaza	Henderson Land Development Company Limited	09/2019
CLP Black Point Power Station D1	CLP Power Hong Kong Ltd.	09/2019
HKSTP Innocell Residential Institution	Hong Kong Science Park	11/2019
Inland Revenue Tower	Architectural Services Department	12/2019
33 Tin Shui Wai, Yuen Long	Sun Hung Kai Properties Ltd	12/2019
YOHO Hub at Yuen Long Station	Sun Hung Kai Properties Ltd/ MTRC	12/2019
Kwai Chung Hospital Phase 2	Hospital Authority	12/2019
Area 54, Siu Hong, Tuen Mun	Sun Hung Kai Properties Ltd	02/2020
Arendelle, Hong Kong Disneyland	HK International Theme Parks Ltd	02/2020
Regal TST Hotel	Regal Hotel Group	02/2020
APIL136, Ap Lei Chau	Unicorn Bay (HK) Investment Ltd	02/2020
Christian Zheng Sheng College	Christian Zheng Sheng College	02/2020
IE2.0, Advanced Manufacturing Centre, TKO	Hong Kong Science Park	03/2020
Tai Po Town Lot 223 & 229	HKR International Limited	03/2020
Town Lot 33, Area 112, Tin Shui Wai	Sun Hung Kai Properties Ltd.	03/2020

# SIEMENS

Butterfly on Prat Boutique Hotel at Tsim Sha Tsui	Butterfly on Prat Boutique Hotel	05/2020
HKAA 3722 Third Runway Site Office	Airport Authority	06/2020
Queen Mary Hospital	Architectural Services Department	06/2020
Penny Bay Phase 2	Architectural Services Department	07/2020
A 30 Classroom primary school at Tokin Street, Cheung Sha Wan	Architectural Services Department	08/2020
Whisker Harbour, Ocean Park	Ocean Park Corporation	10/2020
Penny's Bay Phase 3A	Architectural Services Department	10/2020
Penny's Bay Phase 3B	Architectural Services Department	10/2020
Penny's Bay Phase 4	Civil Engineering and Development Department	11/2020
Adventure Land, Ocean Park	Ocean Park Corporation	11/2020
VAC System for Inland Revenue Tower	Architectural Services Department	11/2020
Second Expansion of DHL Central Asia Hub	DHL Express Hong Kong Ltd.	12/2020
Queen Elizabeth Hospital	Electrical and Mechanical Services Department	12/2020
NKIL6550 Cheung Sha Wan Hotel	Sun Hung Kai Properties Ltd	01/2021
Prince of Wales Hospital - Main Block – H, K, L, & M and Special Block – E & F	Hospital Authority	01/2021
NKIL6582 Cheung Sha Wan Office	New World Development	02/2021
No. 43 Island Road	Chong Hing Bank Limited	02/2021
HKIA C3723 Third Runway Eastern Support Area	Hong Kong International Airport	03/2021
Proposed New Dangerous Goods Store, The Chinese University of Hong Kong	The Chinese University of Hong Kong	03/2021
136 Lei Nam Road & 232 Wan Chai Road	Logan Property Holdings Limited	03/2021
Shopping Centre at Elizabeth House	Cheung Kong Property Holdings Limited	03/2021

Elderly Centre at Ventris Road	Hong Kong Macau Conference Holding Limited	03/2021
To Shek Street, Shatin	Sun Hung Kai Properties Ltd	03/2021
IT Operations Building at Shatin Racecourse	The Hong Kong Jockey Club	03/2021
Good Hope School at Hei Fook Road	Good Hope School	04/2021
Regency Centre 1&2 at 41-43 Wong Chuk Hang Road	Ever Success Holdings Ltd	04/2021
41 King Yip Street, Kwun Tong	Viva Properties Development Limited	04/2021
Kai Tak Sports Park	Architectural Services Department /New World Development	05/2021
C&E Dept at No. 57 Sheung Fung Street, Wong Tai Sin	Architectural Services Department	06/2021
New Academic Building at St. Stephen's College at Stanley	St. Stephen's College	07/2021
Light Rail Tin Wing Stop, Area 33	Sun Hung Kai Properties Ltd/ MTRC	07/2021
NKIL6551 Kai Tak	Sun Hung Kai Properties Ltd	08/2021
Transitional Housing Development at Kong Ha Wai, Kam Tin	Pok Oi Hospital	10/2021
Kwu Tau North Development Area	Civil Engineering and Development Department	12/2021
Summit, Ocean Park	Ocean Park Corporation	12/2021
The Cliveden	Kerry Properties Limited	01/2022
Prince of Wales Hospital - Clinical Sciences Building, Trauma Centre & A/C Room at Prince of Wales Hospital	Hospital Authority	01/2022
Kai Tak Area 4C site 3, NKIL 6551	Sun Hung Kai Properties Ltd	01/2022
Hotel Development at 62 -68 Chun Yeung Street, North Point	Vanke Property Agency Limited	01/2022
Jockey Club One Health Tower and A&A works for Academic Exchange Building at City University Lodge	City University of Hong Kong	02/2022

Proposed T.W.G. Hs Holistic Centre for youth Development at San Po Kong	Tung Wah Group of Hospitals	03/2022
Design & Construction of Immigration Headquarters in Area 67, Tseung Kwan O	Architectural Services Department	03/2022
Kai Tak Isolation Facilities	Architectural Services Department	03/2022
Siu Sai Wan Health Centre	Architectural Services Department	03/2022
RCP at Hung Yuen Road	Architectural Services Department	03/2022
36 Wong Chuk Hang Road	Empire Group Ltd	03/2022
22 Wang Yip Street West	Star Properties HK Ltd.	04/2022
Proposed Office Development at 2 Murray Road, Central	Henderson Land	04/2022
Shui On Centre	Shui On Centre	05/2022
Light Rail in Ting Wing Stop, TSWTL No. 23 Area 33, Tin Shui Wai	Sun Hung Kai Properties Ltd	05/2022
7-9A Cheung Wah Street	Well Century Investments Ltd	05/2022
LOHAS 11 at TKO	Sino Land/ MTRC	06/2022
14 Wang Tai Road	First Group Holdings Ltd	06/2022
918 Cheung Sha Wan Road	First Group Holdings Ltd	06/2022
926 Cheung Sha Wan Road	First Group Holdings Ltd	06/2022
Nexus Building	Jones Lang LaSalle, Inc.	06/2022
Multi-welfare Services Complex in Kwu Tung North	Architectural Services Department	06/2022
Community Health Centre and Social Welfare Facilities Building in Siu Sai Wan	Architectural Services Department	07/2022
Shui On Centre	Socam Development Ltd	07/2022
Hong Kong Baptist University	Hong Kong Baptist University	07/2022

Lyric Theatre Complex	West Kowloon Cultural District	08/2022
The Communal, Lyric Theatre Complex	West Kowloon Cultural District	09/2022
Proposed Office Buildings & shopping mall at KIL 11262 West Kowloon Station	Sun Hung Kai Properties Ltd	10/2022
CLP Black Point Power Station, D2	CLP Power Hong Kong Ltd.	10/2022
West Kowloon Express Railway Link Terminus Commercial Development	Sun Hung Kai Properties	10/2022
37-43 Sha Tsui Road, Tsuen Wan	RealPlus Property Company Limited	10/2022
The Student Residence at Wong Chuk Hang Site, The University of Hong Kong	The University of Hong Kong	11/2022
Proposed Transitional Housing at Wong Yue Tang & Luen Yan Street	The Lok Sin Tong Benevolent Society, Kowloon	11/2022
Immigration Centre, Tseung Kwan O	Immigration Department	11/2022
Proposed Commercial Buildings at No. 7 Lai Yip Street, Kwun Tong	Henderson Land Development Co., Ltd	12/2022
Redevelopment of Kwai Chung Hospital (Phase 2)	Architectural Services Department	12/2022
Prince of Wales Hospital - Li Ka Shing Medical Sciences Building	Hospital Authority	01/2023
Hospital Authority Supporting Services Centre in North Lantau	Hospital Authority	01/2023
Proposed Residential Buildings at Yau Tong Lot 45	Cheung Kong Property Holdings Ltd	02/2023
Upgrade of AFA system at Marine World, Ocean Park	Ocean Park Corporation	03/2023
Proposed Residential Building at YOHO Hub	Sun Hung Kai Properties Ltd	04/2023
Proposed Office Buildings at 14 Wang Tai Road, Kowloon Bay	First Group Holdings Ltd	04/2023
Central Kowloon Route - Yau Ma Tei East	Highways Department	05/2023
Proposed Residential Development at Kai Tak Area 4C, Site 3	Sun Hung Kai Properties Ltd	05/2023

# SIEMENS

Proposed Office Development AIA Tower	AIA International Ltd	05/2023
Proposed Residential Building at LOHAS 11, Tseung Kwan O	Sino Land Company Ltd	06/2023
Proposed Residential Building at Tai Wai Station	New World Development Co., Ltd	06/2023
Transitional Housing Project at DD106 Ngau Tam Mei, Yuen Long	Evangelical Lutheran Church Social Service Hong Kong	07/2023
Proposed residential Buildings at 53 Kwun Tong Road, Kwun Tong	One Link International Holdings, W. S. H. Group	07/2023
Transitional Housing Project at Ping Che Road, Ta Kwu Ling	Pok Oi Hospital	07/2023
Proposed Office Building at 20 Des Voeux Road, Central	Tak Shing Investment Co Ltd	08/2023
Proposed Data Centre at Chai Wan Kok Street & Ma Wo Road	Goodman Aisa Ltd	08/2023
High West Development, The University of Hong Kong	The University of Hong Kong	09/2023
Contract No. DE/201/04 Shek Wu Hui Effluent Polishing Plant - Main Works Stage 1	Drainage Services Department	10/2023
VAC / SPS for GTWW Building 2 & 8, 23-33 Chai Wan Kok Street, Tsuen Wan	Goodman GTWW Investment No. 2 Ltd	11/2023
The Avignon	Sun Hung Kai Properties Ltd	11/2023
No. 6602 Ko Chiu Road, Yau Tong, Kowloon	Sino Land Co., Ltd	12/2023
VAC for Hospital Authority Supporting Services Centre in North Lantau	Hospital Authority	01/2024
Chinese Medicine Hospital	Health Bureau	01/2024
Proposed Residential Development at Discovery Bay Area N1 North	HKR International Ltd	02/2024
Proposed Residential Building at Tai Po	Vanke Holdings (HK) Co., Ltd	02/2024

Town Lot 243

Tung Chung Valley Phase 1	Civil Engineering and Development Department	03/2024
Government Chinese Medicines Testing Institute in TKO	Chinese Medicine Regulatory Office	03/2024
Contract No. EM2003: Central Kowloon Route - Yau Ma Tei West	Highways Department	03/2024
Block BC, Block DE & Block F, Kwai Chung Hospital	Hospital Authority	04/2024
Temporary Transitional Housing Development at D.D. 128 & D.D. 129 and Adjoining Government Land, Lau Fau Shan, Yuen Long	Tung Wah Group of Hospital	05/2024
Joint-User Government Office Building in Area 67, TKO	Architectural Services Department	05/ 2024
Proposed Commercial Development on IL No. 8945 at Caroline Hill Road, Causeway Bay	Hysan Properties Ltd	06/ 2024
Waterfront Area, Ocean Park	Ocean Park Corporation	07/2024
Proposed Hong Kong Polytechnic University - Student Hostel at Tat Hong Avenue, Kowloon Tong	Hong Kong Polytechnic University	08/ 2024
Light Public Housing at Zone 1 & Zone 2 - Yau Pok Road, Phase 1 & Phase 2 - Choi Hing Road, Tuen Mun Area 3A	Architectural Services Department	09/ 2024
Proposed Residential Development at Tong San Tsuen, Yuen Long	Architectural Services Department	10/ 2024
Ventilation & Air Conditioning System Kai Tak Acute Hospital (Site B)	Architectural Services Department	10/ 2024
Transitional Housing at Shuen Wan, Off Ting Kok Road, Tai Po, N. T.	The Society of Rehabilitation and Crime Prevention, Hong Kong	11/ 2024
Design & Construction of the District Court at Caroline Hill Road	Architectural Services Department	11/ 2024
Science Park Expansion Stage 2 Building	Science Park	12/ 2024
Open space with Public Vehicle Park at Yen Chow Street West	Architectural Services Department	12/ 2024



Kai Tak Acute Hospital (Site A)	Architectural Services Department	01/ 2025
Hong Kong International Arbitration Centre (The Headquarters for an International Organization)	Architectural Services Department	01/ 2025